

Welcome Aboard!

Proper care and maintenance is an important part in keeping your Mercury Product operating at peak efficiency for maximum performance and economy. The enclosed Owner's Registration Card is your key to trouble-free family fun. Refer to your **Operation and Maintenance Manual** for full details of your warranty coverage.

Details of your nearest dealer can be found on www.marinepower.com where country maps and full contact information are displayed.

Is your engine properly registered for warranty purpose? Please check on www.marinepower.com. If necessary, please contact your local dealer.

If the outboard motor's serial number plate contains the CE mark in the lower left-hand corner, the following statement applies:

This outboard motor manufactured by Mercury Marine, Fond du Lac, WI, USA or Marine Power Europe Inc. Park Industriel, de Petit-Rechain, Belgium complies with the requirements of the following directives and standards, as amended:

Recreational Craft Directive: 94/25/EC; std. ISO 8665, ISO 11547

Machinery Directive: 98/37/EC,

EMC Directive: 89/336/EC; std. EN50081-1, SAE J551 (CISPR Pub. 12),
EN 50082-1, IEC 61000 PT4-2, IEC 61000 PT4-3



Patrick C. Mackey

President, Mercury Marine, Fond du Lac, WI USA

European Regulations Contact:

Product Environmental Engineering Department, Mercury Marine, Fond du Lac, WI USA

TABLE OF CONTENTS

Warranty Information

Transfer Of Warranty.....	1
Warranty Registration United States And Canada.....	1
Warranty Registration Outside The United States And Canada.....	1
Mercury Marine Two Years Limited Warranty (Europe).....	2
Mercury Marine One Year Limited Warranty (Confederation of Independent States, Middle-East, Africa).....	3
3 Year Limited Warranty Against Corrosion.....	5
Warranty Coverage And Exclusions.....	6

General Information

Boater's Responsibilities.....	8
Before Operating Your Outboard.....	8
Boat Horsepower Capacity.....	8
Outboard Remote Control Models.....	9
Remote Steering Notice.....	9
Lanyard Stop Switch.....	10
Stopping the Boat in an Emergency.....	11
Protecting People In The Water.....	11
Wave And Wake Jumping.....	11
Exhaust Emissions.....	12
Selecting Accessories For Your Outboard.....	13
Safe Boating Suggestions.....	13
Recording Serial Number.....	14
Jet 40 Specifications.....	15
Component Identification.....	16

Installation

Installing Outboard.....	17
--------------------------	----

Transporting

Trailing Boat/Outboard.....	18
-----------------------------	----

Fuel and Oil

Gasoline Recommendations.....	19
Oil Recommendation.....	19
New Engine Gasoline/Oil Break-in Mixture.....	19
Filling Oil Injection System.....	20
Filling Fuel Tank.....	20

Features and Controls

Remote Control Features.....	21
Warning System.....	21

TABLE OF CONTENTS

Engine Over-Speed Limiter.....	23
Power Trim And Tilt.....	23
Manual Tilt System.....	25
Throttle Grip Friction Adjustment - Tiller Handle Models.....	27
Steering Friction Adjustment - Tiller Handle Models.....	27
Replaceable Jet Drive Shear Key.....	28

Operation

Pre-Starting Check List.....	29
Operating In Freezing Temperatures.....	29
Operating In Salt Water Or Polluted Water.....	29
Operating at High Elevations.....	29
Operating In Shallow Water.....	29
How the Jet Drive Operates.....	30
Stopping the Boat in an Emergency.....	30
Steering The Boat.....	31
Mooring The Boat.....	31
Water Intake Blockage.....	31
Clearing A Lodged Impeller.....	32
Engine Break-in Procedure.....	32
Starting The Engine.....	32
Gear Shifting.....	35
Stopping The Engine.....	35
Emergency Starting.....	36

Maintenance

Outboard Care.....	38
EPA Emissions.....	38
Inspection And Maintenance Schedule.....	39
Flushing The Cooling System.....	39
Top Cowl Removal And Installation.....	40
Battery Inspection.....	41
Fuel System.....	41
Exterior Care.....	42
Steering Link Rod Fasteners.....	42
Fuse Replacement.....	43
Corrosion Control Anode.....	43
Spark Plug Inspection and Replacement.....	44
Steering Pull Adjustment.....	44
Worn/Dull Impeller.....	45
Impeller Clearance Adjustment.....	45
Impeller Removal and Installation.....	46
Lubrication Points.....	50
Checking Power Trim Fluid.....	51
Submerged Outboard.....	52

Storage

Storage Preparation.....	53
Protecting External Outboard Components.....	53
Protecting Internal Engine Components.....	53
Jet Drive.....	53

TABLE OF CONTENTS

Positioning Outboard for Storage.....	53
Battery Storage.....	53

Troubleshooting

Starter Motor Will Not Crank The Engine (Electric Start Models).....	54
Engine Will Not Start.....	54
Engine Runs Erratically.....	54
Engine Over-Speed (Excessive RPM).....	54
Performance Loss.....	55
Battery Will Not Hold Charge.....	55

Owner Service Assistance

Local Repair Service.....	56
Service Away From Home.....	56
Parts And Accessories Inquiries.....	56
Service Assistance.....	56
Mercury Marine Service Offices.....	56

WARRANTY INFORMATION

Transfer Of Warranty

The limited warranty is transferable to a subsequent purchaser, but only for the remainder of the unused portion of the limited warranty. This will not apply to products used for commercial applications.

To transfer the warranty to the subsequent owner, send or fax a copy of the bill of sale or purchase agreement, new owner's name, address and engine serial number to Mercury Marine's warranty registration department.

Mercury Marine
Attn: Warranty Registration Department
W6250 W. Pioneer Road
P.O. Box 1939
Fond du Lac, WI 54936-1939
920-929-5054

Upon processing the transfer of warranty, Mercury Marine will send registration verification to the new owner of the product by mail.

There is no charge for this service.

For products purchased outside the United States and Canada, contact the distributor in your country, or the Mercury Marine Service Office closest to you.

Warranty Registration United States And Canada

1. You may change your address at any time, including at time of warranty claim, by calling Mercury Marine or sending a letter or fax with your name, old address, new address, and engine serial number to Mercury Marine's warranty registration department. Your dealer can also process this change of information.

Mercury Marine
Attn: Warranty Registration Department
W6250 W. Pioneer Road
P.O. Box 1939
Fond du Lac, WI 54936-1939
920-929-5054

NOTE: Registration lists must be maintained by Mercury Marine and any dealer on marine products sold in the United States, should a safety recall notification under the Federal Safety Act be required.

2. To be eligible for warranty coverage, the product must be registered with Mercury Marine. At the time of sale, the dealer should complete the warranty registration and immediately submit it to Mercury Marine via MercNET, E-mail, or mail. Upon receipt of this warranty registration, Mercury Marine will record the registration.
3. Upon processing the warranty registration, Mercury Marine will send registration verification by mail to the purchaser of the product. If this registration verification is not received within 30 days, please contact your selling dealer immediately. Warranty coverage is not effective until your product is registered with Mercury Marine.

Warranty Registration Outside The United States And Canada

1. It is important that your selling dealer fills out the Warranty Registration Card completely and mails it to the distributor or Marine Power Service Center responsible for administering the warranty registration/claim program for your area.
2. The Warranty Registration Card identifies your name and address, product model and serial numbers, date of sale, type of use and the selling distributor's/dealer's code number, name and address. The distributor/dealer also certifies that you are the original purchaser and user of the product.
3. A copy of the Warranty Registration Card, designated as the Purchaser's Copy, MUST be given to you immediately after the card has been completely filled out by the selling distributor/dealer. This card represents your factory registration identification, and should be retained by you for future use when required. Should you ever require warranty service on this product, your dealer may ask you for the Warranty Registration Card to verify date of purchase and to use the information on the card to prepare the warranty claim forms.

WARRANTY INFORMATION

4. In some countries, the Marine Power Service Center will issue you a permanent (plastic) Warranty Registration Card within 30 days after receiving the Factory Copy of the Warranty Registration Card from your distributor/dealer. If you receive a plastic Warranty Registration Card, you may discard the Purchaser's Copy that you received from the distributor/dealer when you purchased the product. Ask your distributor/dealer if this plastic card program applies to you.

IMPORTANT: Registration lists must be maintained by the factory and dealer in some countries by law. It is our desire to have ALL products registered at the factory should it ever be necessary to contact you. Make sure your dealer/distributor fills out the warranty registration card immediately and sends the factory copy to the Marine Power International Service Center for your area.

5. For further information concerning the Warranty Registration Card and its relationship to Warranty Claim processing, refer to the International Warranty.

Mercury Marine Two Years Limited Warranty (Europe)

WHAT IS COVERED: Mercury Marine warrants each new Mercury Outboard, Mariner Outboard, Jet Products, Thruster Electric Trolling Motors, Mercruiser Inboard or Sterndrive engine products to be free of defects in material and workmanship during the period described below.

DURATION OF COVERAGE: This Limited Warranty provides coverage for two (2) years from the date the product is first sold to a recreational use retail purchaser, or the date on which the product is first put into service, whichever occurs first. Commercial users of these products receive warranty coverage of two (2) years from the date of first retail sale, or the accumulation of 500 hours of operation, whichever occurs first. Commercial use is defined as any work or employment related use of the product, or any use of the product which generates income, for any part of the warranty period, even if the product is only occasionally used for such purposes. The repair or replacement of parts, or the performance of service under this warranty, does not extend the life of this warranty beyond its original expiration date. Unexpired warranty coverage can be transferred to one recreational use to a subsequent recreational use customer upon proper re-registration of the product.

CONDITIONS THAT MUST BE MET IN ORDER TO OBTAIN WARRANTY COVERAGE: Warranty coverage is available only to retail customers that purchase from a Dealer authorized by Mercury Marine to distribute the product in the country in which the sale occurred, and then only after the Mercury Marine specified pre-delivery inspection process is completed and documented. Warranty coverage becomes available upon proper registration of the product by the authorized dealer. Inaccurate warranty registration information regarding recreational use, or subsequent change of use from recreational to commercial (unless properly re-registered) may void the warranty at the sole discretion of Mercury Marine. Routine maintenance outlined in the Operation and Maintenance Manual must be timely performed in order to maintain warranty coverage. If this maintenance is performed by the retail customer Mercury Marine reserves the right to make future warranty coverage contingent on proof of proper maintenance.

WHAT MERCURY WILL DO: Mercury's sole and exclusive obligation under this warranty is limited to, at our option, repairing a defective part, replacing such part or parts with new or Mercury Marine certified re-manufactured parts, or refunding the purchase price of the Mercury product. Mercury reserves the right to improve or modify products from time to time without assuming an obligation to modify products previously manufactured.

HOW TO OBTAIN WARRANTY COVERAGE: The customer must provide Mercury with a reasonable opportunity to repair, and reasonable access to the product for warranty service. Warranty claims shall be made by delivering the product for inspection to a Mercury dealer authorized to service the product. If purchaser cannot deliver the product to such a dealer, written notice must be given to Mercury. We will then arrange for the inspection and any covered repair. Purchaser in that case shall pay for all related transportation charges and/or travel time. If the service provided is not covered by this warranty, purchaser shall pay for all related labor and material, and any other expenses associated with that service. Purchaser shall not, unless requested by Mercury, ship the product or parts of the product directly to Mercury. The warranty registration card is the only valid registration identification and must be presented to the dealer at the time warranty service is requested in order to obtain coverage.

WARRANTY INFORMATION

WHAT IS NOT COVERED: This limited warranty does not cover routine maintenance items, tune ups, adjustments, normal wear and tear, damage caused by abuse, abnormal use, use of a propeller or gear ratio that does not allow the engine to run in its recommended wide open throttle RPM range (see the Operation and Maintenance Manual), operation of the product in a manner inconsistent with the recommended operation/duty cycle section of the Operation and Maintenance Manual, neglect, accident, submersion, improper installation (proper installation specifications and techniques are set forth in the installation instructions for the product), improper service, use of an accessory or part not manufactured or sold by us, jet pump impellers and liners, operation with fuels, oils or lubricants which are not suitable for use with the product (see the Operation and Maintenance Manual), alteration or removal of parts, or water entering the engine through the fuel intake, air intake or exhaust system. Use of the product for racing or other competitive activity, or operating with a racing type lower unit, at any point, even by a prior owner of the product, voids the warranty.

Expenses related to haul out, launch, towing, storage, telephone, rental, inconvenience, slip fees, insurance coverage, loan payments, loss of time, loss of income, or any other type of incidental or consequential damages are not covered by this warranty. Also, expenses associated with the removal and/or replacement of boat partitions or material caused by boat design for access to the product are not covered by this warranty.

No individual or entity, including Mercury Marine authorized dealers, has been given authority by Mercury Marine to make any affirmation, representation or warranty regarding the product, other than those contained in this limited warranty, and if made, shall not be enforceable against Mercury Marine.

For additional information regarding events and circumstances covered by this warranty, and those that are not, see the Warranty Coverage section of the Operation and Maintenance Manual, incorporated by reference into this warranty.

DISCLAIMERS AND LIMITATIONS:

THE IMPLIED WARRANTIES OF MERCHANTABILITY AND FITNESS FOR A PARTICULAR PURPOSE ARE EXPRESSLY DISCLAIMED. TO THE EXTENT THAT THEY CANNOT BE DISCLAIMED, THE IMPLIED WARRANTIES ARE LIMITED IN DURATION TO THE LIFE OF THE EXPRESS WARRANTY. INCIDENTAL AND CONSEQUENTIAL DAMAGES ARE EXCLUDED FROM COVERAGE UNDER THIS WARRANTY. SOME STATES/COUNTRIES DO NOT ALLOW FOR THE DISCLAIMERS, LIMITATIONS AND EXCLUSIONS IDENTIFIED ABOVE, AS A RESULT, THEY MAY NOT APPLY TO YOU. THIS WARRANTY GIVES YOU SPECIFIC LEGAL RIGHTS, AND YOU MAY ALSO HAVE OTHER LEGAL RIGHTS WHICH VARY FROM STATE TO STATE AND COUNTRY TO COUNTRY.

Mercury Marine One Year Limited Warranty (Confederation of Independent States, Middle-East, Africa)

WHAT IS COVERED: Mercury Marine warrants each new Mercury outboard, Mariner outboard, Jet Products, Thruster Electric Trolling Motors, Mercruiser Inboard or Sterndrive engine products to be free of defects in material and workmanship during the period described below.

DURATION OF COVERAGE: This Limited Warranty provides coverage for one (1) year from the date the product is first sold to a recreational use retail purchaser, or the date on which the product is first put into service, whichever occurs first. Commercial users of these products receive warranty coverage of one (1) years from the date of first retail sale, or the accumulation of 500 hours of operation, whichever occurs first. Commercial use is defined as any work or employment related use of the product, or any use of the product which generates income, for any part of the warranty period, even if the product is only occasionally used for such purposes. The repair or replacement of parts, or the performance of service under this warranty, does not extend the life of this warranty beyond its original expiration date. Unexpired warranty coverage can be transferred to a subsequent purchaser upon proper re-registration of the product.

WARRANTY INFORMATION

CONDITIONS THAT MUST BE MET IN ORDER TO OBTAIN WARRANTY COVERAGE: Warranty coverage is available only to retail customers that purchase from a Dealer authorized by Mercury Marine to distribute the product in the country in which the sale occurred, and then only after the Mercury Marine specified pre-delivery inspection process is completed and documented. Warranty coverage becomes available upon proper registration of the product by the authorized dealer. Inaccurate warranty registration information regarding recreational use, or subsequent change of use from recreational to commercial (unless properly re-registered) may void the warranty at the sole discretion of Mercury Marine. Routine maintenance outlined in the Operation and Maintenance Manual must be timely performed in order to maintain warranty coverage. If this maintenance is performed by the retail customer Mercury Marine reserves the right to make future warranty coverage contingent on proof of proper maintenance.

WHAT MERCURY WILL DO: Mercury's sole and exclusive obligation under this warranty is limited to, at our option, repairing a defective part, replacing such part or parts with new or Mercury Marine certified re-manufactured parts, or refunding the purchase price of the Mercury product. Mercury reserves the right to improve or modify products from time to time without assuming an obligation to modify products previously manufactured.

HOW TO OBTAIN WARRANTY COVERAGE: The customer must provide Mercury with a reasonable opportunity to repair, and reasonable access to the product for warranty service. Warranty claims shall be made by delivering the product for inspection to a Mercury dealer authorized to service the product. If purchaser cannot deliver the product to such a dealer, written notice must be given to Mercury. We will then arrange for the inspection and any covered repair. Purchaser in that case shall pay for all related transportation charges and/or travel time. If the service provided is not covered by this warranty, purchaser shall pay for all related labor and material, and any other expenses associated with that service. Purchaser shall not, unless requested by Mercury, ship the product or parts of the product directly to Mercury. The warranty registration card is the only valid registration identification and must be presented to the dealer at the time warranty service is requested in order to obtain coverage.

WHAT IS NOT COVERED: This limited warranty does not cover routine maintenance items, tune ups, adjustments, normal wear and tear, damage caused by abuse, abnormal use, use of a propeller or gear ratio that does not allow the engine to run in its recommended wide open throttle RPM range (see the Operation and Maintenance Manual), operation of the product in a manner inconsistent with the recommended operation/duty cycle section of the Operation and Maintenance Manual, neglect, accident, submersion, improper installation (proper installation specifications and techniques are set forth in the installation instructions for the product), improper service, use of an accessory or part not manufactured or sold by us, jet pump impellers and liners, operation with fuels, oils or lubricants which are not suitable for use with the product (see the Operation and Maintenance Manual), alteration or removal of parts, or water entering the engine through the fuel intake, air intake or exhaust system. Use of the product for racing or other competitive activity, or operating with a racing type lower unit, at any point, even by a prior owner of the product, voids the warranty.

Expenses related to haul out, launch, towing, storage, telephone, rental, inconvenience, slip fees, insurance coverage, loan payments, loss of time, loss of income, or any other type of incidental or consequential damages are not covered by this warranty. Also, expenses associated with the removal and/or replacement of boat partitions or material caused by boat design for access to the product are not covered by this warranty.

No individual or entity, including Mercury Marine authorized dealers, has been given authority by Mercury Marine to make any affirmation, representation or warranty regarding the product, other than those contained in this limited warranty, and if made, shall not be enforceable against Mercury Marine.

For additional information regarding events and circumstances covered by this warranty, and those that are not, see the Warranty Coverage section of the Operation and Maintenance Manual, incorporated by reference into this warranty.

WARRANTY INFORMATION

DISCLAIMERS AND LIMITATIONS:

THE IMPLIED WARRANTIES OF MERCHANTABILITY AND FITNESS FOR A PARTICULAR PURPOSE ARE EXPRESSLY DISCLAIMED. TO THE EXTENT THAT THEY CANNOT BE DISCLAIMED, THE IMPLIED WARRANTIES ARE LIMITED IN DURATION TO THE LIFE OF THE EXPRESS WARRANTY. INCIDENTAL AND CONSEQUENTIAL DAMAGES ARE EXCLUDED FROM COVERAGE UNDER THIS WARRANTY. SOME STATES/COUNTRIES DO NOT ALLOW FOR THE DISCLAIMERS, LIMITATIONS AND EXCLUSIONS IDENTIFIED ABOVE, AS A RESULT, THEY MAY NOT APPLY TO YOU. THIS WARRANTY GIVES YOU SPECIFIC LEGAL RIGHTS, AND YOU MAY ALSO HAVE OTHER LEGAL RIGHTS WHICH VARY FROM STATE TO STATE AND COUNTRY TO COUNTRY.

3 Year Limited Warranty Against Corrosion

WHAT IS COVERED: Mercury Marine warrants that each new Mercury, Mariner, Mercury Racing, Sport Jet, M² Jet Drive, Tracker by Mercury Marine Outboard, MerCruiser Inboard or sterndrive engine (Product) will not be rendered inoperative as a direct result of corrosion for the period of time described below.

DURATION OF COVERAGE: This limited corrosion warranty provides coverage for three (3) years from either the date the product is first sold, or the date on which the product is first put into service, whichever occurs first. The repair or replacement of parts, or the performance of service under this warranty does not extend the life of this warranty beyond its original expiration date. Unexpired warranty coverage can be transferred to subsequent (non-commercial use) purchaser upon proper re-registration of the product.

CONDITIONS THAT MUST BE MET IN ORDER TO OBTAIN WARRANTY COVERAGE: Warranty coverage is available only to retail customers that purchase from a Dealer authorized by Mercury Marine to distribute the product in the country in which the sale occurred, and then only after the Mercury Marine specified pre-delivery inspection process is completed and documented. Warranty coverage becomes available upon proper registration of the product by the authorized dealer. Corrosion prevention devices specified in the Operation and Maintenance Manual must be in use on the boat, and routine maintenance outlined in the Operation and Maintenance Manual must be timely performed (including without limitation the replacement of sacrificial anodes, use of specified lubricants, and touch-up of nicks and scratches) in order to maintain warranty coverage. Mercury Marine reserves the right to make warranty coverage contingent upon proof of proper maintenance.

WHAT MERCURY WILL DO: Mercury's sole and exclusive obligation under this warranty is limited to, at our option, repairing a corroded part, replacing such part or parts with new or Mercury Marine certified re-manufactured parts, or refunding the purchase price of the Mercury product. Mercury reserves the right to improve or modify products from time to time without assuming an obligation to modify products previously manufactured.

HOW TO OBTAIN WARRANTY COVERAGE: The customer must provide Mercury with a reasonable opportunity to repair, and reasonable access to the product for warranty service. Warranty claims shall be made by delivering the product for inspection to a Mercury dealer authorized to service the product. If purchaser cannot deliver the product to such a dealer, written notice must be given to Mercury. We will then arrange for the inspection and any covered repair. Purchaser in that case shall pay for all related transportation charges and/or travel time. If the service provided is not covered by this warranty, purchaser shall pay for all related labor and material, and any other expenses associated with that service. Purchaser shall not, unless requested by Mercury, ship the product or parts of the product directly to Mercury. Proof of registered ownership must be presented to the dealer at the time warranty service is requested in order to obtain coverage.

WHAT IS NOT COVERED: This limited warranty does not cover electrical system corrosion; corrosion resulting from damage, corrosion which causes purely cosmetic damage, abuse or improper service; corrosion to accessories, instruments, steering systems; corrosion to factory installed jet drive unit; damage due to marine growth; product sold with less than a one year limited Product warranty; replacement parts (parts purchased by customer); products used in a commercial application. Commercial use is defined as any work or employment related use of the product, or any use of the product which generates income, for any part of the warranty period, even if the product is only occasionally used for such purposes.

WARRANTY INFORMATION

Corrosion damage caused by stray electrical currents (on-shore power connections, nearby boats, submerged metal) is not covered by this corrosion warranty and should be protected against by the use of a corrosion protection system, such as the Mercury Precision Parts or Quicksilver MerCathode system and/or Galvanic Isolator. Corrosion damage caused by improper application of copper base anti-fouling paints is also not covered by this limited warranty. If anti-fouling protection is required, Tri-Butyl-Tin-Adipate (TBTA) base anti-fouling paints are recommended on Outboard and MerCruiser boating applications. In areas where TBTA base paints are prohibited by law, copper base paints can be used on the hull and transom. Do not apply paint to the outboard or MerCruiser product. In addition, care must be taken to avoid an electrical interconnection between the warranted product and the paint. For MerCruiser product, an unpainted gap of at least 38 mm (1.5 in.) should be left around the transom assembly. Refer to the Operation and Maintenance Manual for additional details.

For additional information regarding events and circumstances covered by this warranty, and those that are not, see the Warranty Coverage section of the Operation and Maintenance Manual, incorporated by reference into this warranty.

DISCLAIMERS AND LIMITATIONS:

THE IMPLIED WARRANTIES OF MERCHANTABILITY AND FITNESS FOR A PARTICULAR PURPOSE ARE EXPRESSLY DISCLAIMED. TO THE EXTENT THAT THEY CANNOT BE DISCLAIMED, THE IMPLIED WARRANTIES ARE LIMITED IN DURATION TO THE LIFE OF THE EXPRESS WARRANTY. INCIDENTAL AND CONSEQUENTIAL DAMAGES ARE EXCLUDED FROM COVERAGE UNDER THIS WARRANTY. SOME STATES/COUNTRIES DO NOT ALLOW FOR THE DISCLAIMERS, LIMITATIONS AND EXCLUSIONS IDENTIFIED ABOVE, AS A RESULT, THEY MAY NOT APPLY TO YOU. THIS WARRANTY GIVES YOU SPECIFIC LEGAL RIGHTS, AND YOU MAY ALSO HAVE OTHER LEGAL RIGHTS WHICH VARY FROM STATE TO STATE AND COUNTRY TO COUNTRY.

Warranty Coverage And Exclusions

The purpose of this section is to help eliminate some of the more common misunderstandings regarding warranty coverage. The following information explains some of the types of services that are not covered by warranty. The provisions set forth following have been incorporated by reference into the Three Year Limited Warranty Against Corrosion Failure, the International Limited Outboard Warranty, and the United States and Canada Limited Outboard Warranty.

Keep in mind that warranty covers repairs that are needed within the warranty period because of defects in material and workmanship. Installation errors, accidents, normal wear, and a variety of other causes that affect the product are not covered.

Warranty is limited to defects in material or workmanship, but only when the consumer sale is made in the country to which distribution is authorized by us.

Should you have any questions concerning warranty coverage, contact your authorized dealer. They will be pleased to answer any questions that you may have.

GENERAL EXCLUSIONS FROM WARRANTY

1. Minor adjustments and tune-ups, including checking, cleaning or adjusting spark plugs, ignition components, carburetor settings, filters, belts, controls, and checking lubrication made in connection with normal services.
2. Factory installed jet drive units - Specific parts excluded from the warranty are: The jet drive impeller and jet drive liner damaged by impact or wear, and water damaged drive shaft bearings as a result of improper maintenance.
3. Damage caused by neglect, lack of maintenance, accident, abnormal operation or improper installation or service.
4. Haul out, launch, towing charges, removal and/or replacement of boat partitions or material because of boat design for necessary access to the product, all related transportation charges and/or travel time, etc. Reasonable access must be provided to the product for warranty service. Customer must deliver product to an authorized dealer.
5. Additional service work requested by customer other than that necessary to satisfy the warranty obligation.

WARRANTY INFORMATION

6. Labor performed by other than an authorized dealer may be covered only under following circumstances: When performed on emergency basis (providing there are no authorized dealers in the area who can perform the work required or have no facilities to haul out, etc., and prior factory approval has been given to have the work performed at this facility).
7. All incidental and/or consequential damages (storage charges, telephone or rental charges of any type, inconvenience or loss of time or income) are the owner's responsibility.
8. Use of other than Mercury Precision or Quicksilver parts when making warranty repairs.
9. Oils, lubricants or fluids changed as a matter of normal maintenance is customer's responsibility unless loss or contamination of same is caused by product failure that would be eligible for warranty consideration.
10. Participating in or preparing for racing or other competitive activity or operating with a racing type lower unit.
11. Engine noise does not necessarily indicate a serious engine problem. If diagnosis indicates a serious internal engine condition which could result in a failure, condition responsible for noise should be corrected under the warranty.
12. Lower unit and/or propeller damage caused by striking a submerged object is considered a marine hazard.
13. Water entering engine through the fuel intake, air intake or exhaust system or submersion.
14. Failure of any parts caused by lack of cooling water, which results from starting motor out of water, foreign material blocking inlet holes, motor being mounted too high or trimmed too far out.
15. Use of fuels and lubricants which are not suitable for use with or on the product. Refer to the **Maintenance** section.
16. Our limited warranty does not apply to any damage to our products caused by the installation or use of parts and accessories which are not manufactured or sold by us. Failures which are not related to the use of those parts or accessories are covered under warranty if they otherwise meet the terms of the limited warranty for that product.

GENERAL INFORMATION

Boater's Responsibilities

The operator (driver) is responsible for the correct and safe operation of the boat and safety of its occupants and general public. It is strongly recommended that each operator (driver) read and understand this entire manual before operating the outboard.

Be sure at least one additional person on board is instructed in the basics of starting and operating the outboard and boat handling in case the driver is unable to operate the boat.

Before Operating Your Outboard

Read this manual carefully. Learn the difference in handling characteristics between a jet drive boat and a propeller driven boat. If you have any questions, contact your dealer.

STEERING AT LOW SPEEDS

Unlike propeller driven boats, the jet drive boat tends to lose steering control as less water is drawn in and expelled. Increase speed slightly to regain steering.

MANEUVERABILITY

The jet drive is highly maneuverable at higher speeds, more so, than propeller driven boats. Use caution when turning to prevent spin-outs.

IN NEUTRAL

The impeller will continue to rotate while the engine is in neutral. Although the approximate balancing of forward and reverse thrust will minimize boat movement, the boat may tend to move slowly forward or backward. This is normal for a direct-drive jet driven boat. The operator should be aware of this and use caution whenever the engine is running.

Safety and operating information that is practiced, along with using good common sense, can help prevent personal injury and product damage.

This manual as well as safety labels posted on the outboard use the following safety alerts to draw your attention to special safety instructions that should be followed.

DANGER

DANGER - indicates an imminently hazardous situation that, if not avoided, will result in death or serious injury.

WARNING

WARNING - indicates a potentially hazardous situation that, if not avoided, could result in death or serious injury.

CAUTION

CAUTION - indicates a potentially hazardous situation that, if not avoided, may result in minor or moderate injury or property damage. It may also be used to alert against unsafe practices.

Boat Horsepower Capacity

WARNING

Using an outboard that exceeds the maximum horsepower limit of a boat can: 1) cause loss of boat control 2) place too much weight at the transom altering the designed flotation characteristics of the boat or 3) cause the boat to break apart particularly around the transom area. Overpowering a boat can result in serious injury, death or boat damage.

Do not overpower or overload your boat. Most boats will carry a required capacity plate indicating the maximum acceptable power and load as determined by the manufacturer following certain federal guidelines. If in doubt, contact your dealer or the boat manufacturer.

GENERAL INFORMATION

U.S. COAST GUARD CAPACITY	
MAXIMUM HORSEPOWER	XXX
MAXIMUM PERSON CAPACITY (POUNDS)	XXX
MAXIMUM WEIGHT CAPACITY	XXX

ob00306

Outboard Remote Control Models

The remote control connected to your outboard must be equipped with a start in neutral only protection device. This prevents the engine from starting when the shift is actuated in any position other than neutral.

WARNING

Avoid serious injury or death from a sudden unexpected acceleration when starting your engine. The design of this outboard requires that the remote control used with it must have a built in start in neutral only protection device.

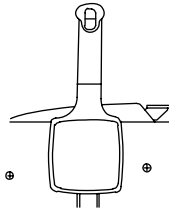

ob00308

Remote Steering Notice

WARNING

Disengagement of a steering link rod can result in the boat taking a full, sudden, sharp turn. This potentially violent action can cause occupants to be thrown overboard exposing them to serious injury or death.

The steering link rod that connects the steering cable to the engine must be fastened utilizing self-locking nuts. These self-locking nuts must never be replaced with common nuts (non-locking) as they will work loose and vibrate off, freeing the link rod to disengage.

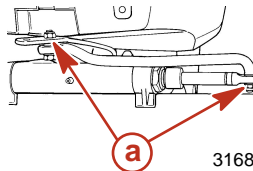

3168

a - Self-locking nuts

GENERAL INFORMATION

Lanyard Stop Switch

The purpose of a lanyard stop switch is to turn off the engine when the operator moves far enough away from the operator's position (as in accidental ejection from the operator's position) to activate the switch. Tiller handle outboards and some remote control units are equipped with a lanyard stop switch. A lanyard stop switch can be installed as an accessory - generally on the dashboard or side adjacent to the operator's position.

The lanyard is a cord usually between 122 and 152 cm (4 and 5 feet) in length when stretched out, with an element on one end made to be inserted into the switch and a snap on the other end for attaching to the operator. The lanyard is coiled to make its at-rest condition as short as possible to minimize the likelihood of lanyard entanglement with nearby objects. Its stretched-out length is made to minimize the likelihood of accidental activation should the operator choose to move around in an area close to the normal operator's position. If it is desired to have a shorter lanyard, wrap the lanyard around the operator's wrist or leg, or tie a knot in the lanyard.

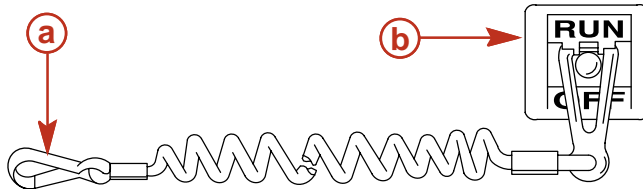

a - Lanyard cord

b - Lanyard stop switch

ob00310

Read the following Safety Information before proceeding.

Important Safety Information: The purpose of a lanyard stop switch is to stop the engine when the operator moves far enough away from the operator's position to activate the switch. This would occur if the operator accidentally falls overboard or moves within the boat a sufficient distance from the operator's position. Falling overboard and accidental ejections are more likely to occur in certain types of boats such as low sided inflatables, bass boats, high performance boats, and light, sensitive handling fishing boats operated by a hand tiller. Falling overboard and accidental ejections are also likely to occur as a result of poor operating practices such as sitting on the back of the seat or gunwale at planing speeds, standing at planing speeds, sitting on elevated fishing boat decks, operating at planing speeds in shallow or obstacle infested waters, releasing your grip on a steering wheel or tiller handle that is pulling in one direction, drinking alcohol or consuming drugs, or daring, high speed boat maneuvers.

While activation of the lanyard stop switch will stop the engine immediately, a boat will continue to coast for some distance depending upon the velocity and degree of any turn at shut down. However, the boat will not complete a full circle. While the boat is coasting, it can cause injury to anyone in the boat's path as seriously as the boat would when under power.

We strongly recommend that other occupants be instructed on proper starting and operating procedures should they be required to operate the engine in an emergency (e.g. if the operator is accidentally ejected).

WARNING

Should the operator fall out of the boat, the possibility of serious injury or death from being run over by the boat can be greatly reduced by stopping the engine immediately. Always properly connect both ends of the stop switch lanyard to the stop switch and the operator.

WARNING

Avoid serious injury or death from deceleration forces resulting from accidental or unintended stop switch activation. The boat operator should never leave the operator's station without first disconnecting the stop switch lanyard from the operator.

GENERAL INFORMATION

Accidental or unintended activation of the switch during normal operation is also a possibility. This could cause any, or all, of the following potentially hazardous situations:

- Occupants could be thrown forward due to unexpected loss of forward motion - a particular concern for passengers in the front of the boat who could be ejected over the bow and possibly struck by the jet drive.
- Loss of power and directional control in heavy seas, strong current or high winds.
- Loss of control when docking.

Stopping the Boat in an Emergency

A jet powered boat has emergency stopping capability unique to this form of propulsion.

WARNING

Using the emergency stopping capability of the jet drive will slow down the boat in an emergency. However, sudden stopping may cause the occupants in the boat to be thrown forward or even out of the boat. This action may result in serious injury or death.

In an emergency, putting the jet outboard into reverse and applying reverse throttle can rapidly slow down the boat and reduce stopping distance. However, such a maneuver may cause occupants in the boat to be thrown forward or possibly out of the boat.

Protecting People In The Water

WHILE YOU ARE CRUISING

It is very difficult for a person standing or floating in the water to take quick action to avoid a boat heading in his/her direction, even at slow speed.



ob00311

Always slow down and exercise extreme caution when boating in an area where there might be people in the water. Avoid shallow water or where any loose material such as sand, shells, seaweed, grass, tree branches, etc., can be pulled in and expelled from the pump as a high speed projectile.

WHILE BOAT IS STATIONARY

WARNING

Avoid injury resulting from contacting the rotating impeller or having hair, clothing or loose objects drawn into the water intake and wrapping around the impeller shaft. Stay away from the water intake and never insert an object into the water intake or water outlet nozzle when the engine is running.

Stop the engine immediately whenever a person is in the water near the boat. The jet drive is always drawing water through the water intake when the engine is running. Stay away from the water intake located under the jet drive and never insert an object into the water intake or outlet nozzle when the engine is running.

Wave And Wake Jumping

Operating recreational boats over waves and wake is a natural part of boating. However, when this activity is done with sufficient speed to force the boat hull partially or completely out of the water, certain hazards arise, particularly when the boat re-enters the water.

GENERAL INFORMATION

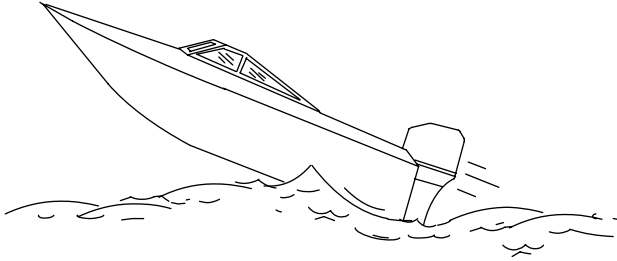

ob00314

The primary concern is the boat changing direction while in the midst of the jump. In such case the landing may cause the boat to veer violently in a new direction. Such a sharp change in direction can cause occupants to be thrown out of their seats, or out of the boat.

WARNING

Avoid serious injury or death from being thrown within or out of a boat when it lands after jumping a wave or wake. Avoid wave or wake jumping whenever possible. Instruct all occupants that if a wake or wave jump occurs, get low and hang on to a boat hand hold.

There is another less common hazardous result from allowing your boat to launch off a wave or wake. If the bow of your boat pitches down far enough while airborne, upon water contact it may penetrate under the water surface and submarine for an instant. This will bring the boat to a nearly instantaneous stop and can send the occupants flying forward. The boat may also steer sharply to one side.

Exhaust Emissions

BE ALERT TO CARBON MONOXIDE POISONING

Carbon monoxide is present in the exhaust fumes of all internal combustion engines. This includes the outboards, sterndrives and inboard engines that propel boats, as well as the generators that power various boat accessories. Carbon monoxide is a deadly gas that is odorless, colorless and tasteless.

Early symptoms of carbon monoxide poisoning which should not be confused with seasickness or intoxication, include headache, dizziness, drowsiness, and nausea.

WARNING

Avoid the combination of a running engine and poor ventilation. Prolonged exposure to carbon monoxide in sufficient concentration can lead to unconsciousness, brain damage, or death.

GOOD VENTILATION

Ventilate passenger area, open side curtains, or forward hatches to remove fumes.

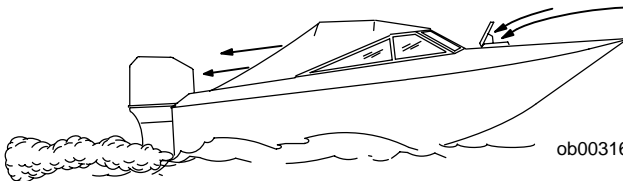

ob00316

Example of desired air flow through the boat.

POOR VENTILATION

Under certain running and/or wind conditions, permanently enclosed or canvas enclosed cabins or cockpits with insufficient ventilation may draw in carbon monoxide. Install one or more carbon monoxide detectors in your boat.

GENERAL INFORMATION

Although the occurrence is rare, on a very calm day, swimmers and passengers in an enclosed area of a stationary boat that contains or is near a running engine may be exposed to a hazardous level of carbon monoxide.

WHILE BOAT IS STATIONARY

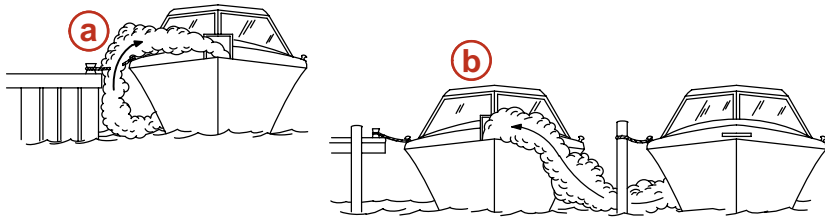

ob00317

- a- Running the engine when the boat is moored in a confined space.
- b- Mooring close to another boat that has its engine running.

WHILE BOAT IS MOVING

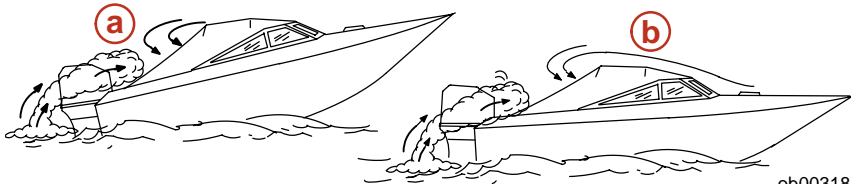

ob00318

- a- Running the boat with the trim angle of the bow too high.
- b- Running the boat with no forward hatches open.

Selecting Accessories For Your Outboard

Genuine Mercury Precision or Quicksilver Accessories have been specifically designed and tested for your outboard. These accessories are available from Mercury Marine dealers.

WARNING

Check with your dealer before installation of accessories. The misuse of acceptable accessories or the use of unacceptable accessories can result in serious injury, death, or product failure.

Some accessories not manufactured or sold by Mercury Marine are not designed to be safely used with your outboard or outboard operating system. Acquire and read the installation, operation, and maintenance manuals for all your selected accessories.

Safe Boating Suggestions

In order to safely enjoy the waterways, the operator should be familiar with local and other governmental boating regulations and restrictions, and consider the following suggestions.

Use flotation devices. Have an approved personal flotation device of suitable size for each person aboard (it is the law) and have it readily accessible.

Do not overload your boat. Most boats are rated and certified for maximum load (weight) capacities (refer to your boat capacity plate). If in doubt, contact your dealer or the boats manufacturer.

Perform safety checks and required maintenance. Follow a regular schedule and ensure that all repairs are properly made.

GENERAL INFORMATION

Know and obey all nautical rules and laws of the waterways. Boat operators should complete a boating safety course. Courses are offered in the U.S.A. by 1) The U.S. Coast Guard Auxiliary, 2) The Power Squadron, 3) The Red Cross and 4) any state boating law enforcement agency. Inquiries may be made to the Boating Hotline, 1-800-368-5647 or the Boat U.S. Foundation information number 1-800-336-BOAT.

Make sure everyone in the boat is properly seated. Do not allow anyone to sit or ride on any part of the boat that was not intended for such use. This includes the back of seats, gunwales, transom, bow, decks, raised fishing seats, any rotating fishing seat; or anywhere that an unexpected acceleration, sudden stopping, unexpected loss of boat control, or sudden boat movement could cause a person to be thrown overboard or into the boat.

Never be under the influence of alcohol or drugs while boating (it is the law). Alcohol or drug use impairs judgment and greatly reduces the ability to react quickly.

Prepare other boat operators. Instruct at least one other person on board in the basics of starting and operating the jet drive, and boat handling, in case the driver becomes disabled or falls overboard.

Passenger boarding. Stop the engine whenever passengers are boarding, unloading, or are near the back (stern) of the boat. Just shifting the outboard into neutral is not sufficient.

Be alert. The operator of the boat is responsible by law to maintain a proper lookout by sight and hearing. The operator must have an unobstructed view particularly to the front. No passengers, load, or fishing seats should block the operators view when operating the boat above idle speed.

Avoid shallow water conditions. Never operate the jet drive in very shallow water or where there is a noticeable amount of floating debris or weeds. Always be in at least 61 to 91 cm (2 to 3 ft.) of water. Any loose material such as sand, shells, seaweed, grass, tree branches, etc., can be pulled in by the pump. This may not only block the water flow and cause loss of steering control, but can be expelled from the rear of the pump as a high-speed projectile.

Watch for boat movement in neutral. When the jet drive is in neutral, the drive impeller continues to rotate. Although the approximate balancing of forward and reverse thrust will minimize boat movement, the boat may tend to move slowly forward or backward. This is normal for a direct-drive jet driven boat. The operator should be aware of this and use caution whenever the engine is running.

Never drive the boat directly behind a water skier in case the skier falls. As an example, a boat traveling at 40 km/hr (25 MPH) will overtake a fallen skier 61 m (200 ft.) in front of the boat in 5 seconds.

Watch fallen skiers. When using the boat for water skiing or similar activities, always keep a fallen or down skier on the operator's side of the boat while returning to assist the skier. The operator should always have the down skier in sight and never back up to the skier or anyone in the water.

Report accidents. Boat operators are required by law to file a Boating Accident Report with their state boating law enforcement agency when the boat is involved in certain boating accidents. A boating accident must be reported if 1) there is loss of life or probable loss of life, 2) there is personal injury requiring medical treatment beyond first aid, 3) there is damage to boats or other property where the damage value exceeds \$500.00 or 4) there is complete loss of the boat. Seek further assistance from local law enforcement.

Recording Serial Number

It is important to record this number for future reference. The serial number is located on the outboard as shown.

GENERAL INFORMATION

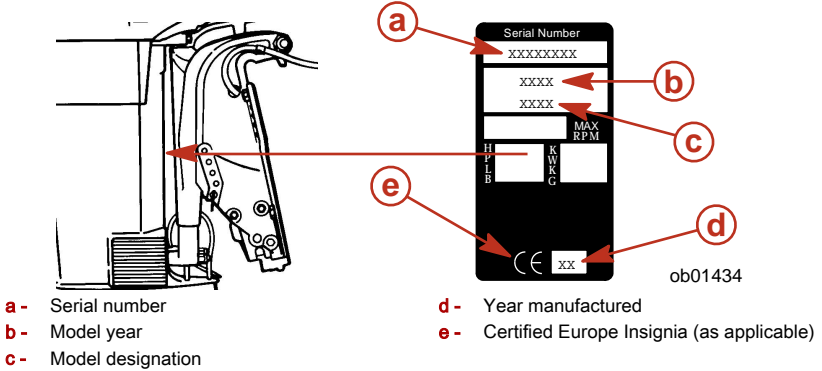

Jet 40 Specifications

Models	40
Jet Power	40
Engine Horsepower	60
Full Throttle RPM Range	5000 - 5500 RPM
Idle Speed in Forward Gear	650 ± 700 RPM
Number of Cylinders	3
Piston Displacement	965 cc (58.9 cu. in.)
Cylinder Bore	76 mm (2.99 in.)
Stroke	71 mm (2.8 in.)
Recommended Spark Plug	NGK BPZ8H-N-10
Spark Plug Gap	1.0 mm (0.040 in.)
Recommended Gasoline	Refer to Fuel & Oil
Recommended Oil	Refer to Fuel & Oil
Battery Rating	465 Marine Cranking Amps (MCA) or 350 Cold Cranking AMPS (CCA)
Ampere Hours (Ah)	70-100

GENERAL INFORMATION

Component Identification

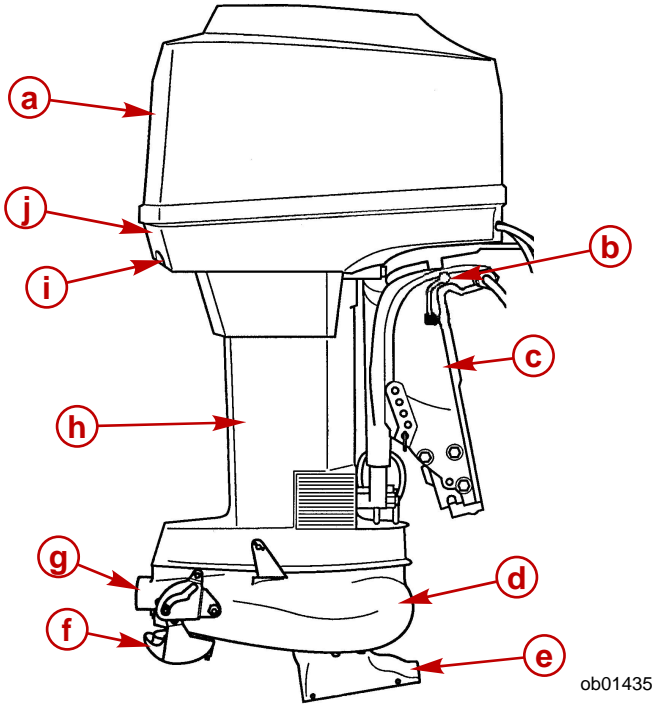

ob01435

- | | |
|---------------------------------|--------------------------------------|
| a - Top Cowl | f - Reverse gate |
| b - Tilt lock lever | g - Water outlet nozzle |
| c - Transom bracket | h - Driveshaft housing |
| d - Jet drive housing | i - Water pump indicator hole |
| e - Water intake housing | j - Bottom cowl |

INSTALLATION

Installing Outboard

WARNING

Before operation, the outboard must be correctly installed with the required mounting hardware as shown. Failure to correctly fasten outboard could result in outboard ejecting off boat transom causing serious injury, death, or property damage.

We strongly recommend that your dealer install your outboard and related accessories to ensure proper installation and good performance. If you install the outboard yourself, follow instructions in the outboard installation manual which is provided with the outboard.

The outboard must be secured to the transom with the four 12.7 mm (1/2 in.) diameter mounting bolts and locknuts provided. Install two bolts through the upper set of holes and two bolts through the lower set of holes.

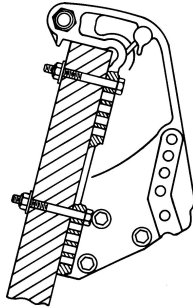

ob00321

TRANSPORTING

Trailing Boat/Outboard

The boat should be trailered with the outboard tilted down in a vertical operating position.

IMPORTANT: Do not rely on the power trim/tilt system or tilt support lever to maintain proper ground clearance for trailering. The outboard tilt support lever is not intended to support the outboard for trailering.

If additional ground clearance is required, the outboard should be tilted up using an accessory outboard support device. Refer to your local dealer for recommendations. Additional clearance may be required for railroad crossings, driveways and trailer bouncing.

FUEL AND OIL

Gasoline Recommendations

UNITED STATES AND CANADA

Use a major brand of automotive unleaded gasoline with a minimum posted octane rating of 87. Mid-grade automotive gasolines that contain fuel injector cleaner are preferred for added internal engine cleanliness. Leaded gasoline is not recommended.

INTERNATIONAL

Use a major brand of automotive unleaded gasoline with a minimum posted octane rating of 90RON. Automotive gasolines that contain fuel injector cleaner are preferred for added internal engine cleanliness. Leaded gasoline is acceptable in areas where unleaded gasoline is not available.

USING REFORMULATED (OXYGENATED) FUELS - UNITED STATES ONLY

This type of fuel is required in certain areas of the United States. The two types of reformulated ingredients in these fuels are alcohol (Ethanol) or Ether (MTBE or ETBE). If Ethanol is the oxygenates that is used in the gasoline, refer to **Alcohol in Gasoline**.

These reformulated fuels are acceptable for use in the Mercury engine.

ALCOHOL IN GASOLINE

We do not recommend the use of gasoline which contains alcohol because of the possible adverse effect the alcohol may have on the fuel system. In general, if only gasoline containing alcohol is available, it must not contain more than 10% ethanol or 5% methanol, and the addition of a water separating fuel filter is recommended.

If gasoline containing alcohol is used or if you suspect the presence of alcohol in your gasoline, increase your inspection of the fuel system, visually checking for fuel leaks or abnormalities.

Gasoline containing alcohol may cause the following problems to your outboard and fuel system:

- Corrosion of metal parts
- Deterioration of elastomers and plastic parts
- Wear and damage of internal engine parts
- Starting and operating difficulties
- Vapor lock or fuel starvation

Some of these adverse effects are due to the tendency of gasoline containing alcohol to absorb moisture from the air, resulting in a phase of water and alcohol which separates from the gasoline in the fuel tank.

The adverse effects of alcohol are more severe with methanol and are worse with increasing content of alcohol.

Oil Recommendation

Recommended Oil	Mercury or Quicksilver Premium 2-Cycle TC-W3 Outboard Oil
-----------------	---

IMPORTANT: Oil must be NMMA certified TC-W3 2-Cycle oil.

Mercury or Quicksilver Premium TC-W3 2-Cycle oil is recommended for this engine. For added protection and lubrication, Mercury or Quicksilver Premium Plus TC-W3 2-Cycle oil is recommended. If Mercury or Quicksilver outboard oil is not available, substitute another brand of 2-cycle outboard oil that is NMMA Certified TC-W3. Severe engine damage may result from use of an inferior oil.

New Engine Gasoline/Oil Break-in Mixture

Use a 50:1 (2%) gasoline/oil mixture in the first tank of fuel. Refer to the following table for mixing ratios. Use of this fuel mixture combined with oil from the oil injection system will supply adequate lubrication during engine break-in.

After the break-in fuel mixture is used up, it is no longer necessary to add oil with the gasoline.

NOTE: At the end of the break-in period, visually check to see if the oil level in the oil injection tank has dropped. Oil usage indicates the oil injection system is functioning correctly.

FUEL AND OIL

GASOLINE/OIL MIXING RATIO CHART			
Gas/Oil Ratio	3.8 liters (1 gal.) gas	11.5 liters (3 gal.) gas	23 liters (6 gal.) gas
50:1 (2%)	89 ml (3 fl. oz.) oil	237 ml (8 fl. oz.) oil	473 ml (16 fl. oz.) oil

MIXING GASOLINE AND OIL

Portable Tank - Pour 4 liters (1 gallon) of gasoline into tank. Add the correct amount of oil and mix thoroughly. Add the remainder of gasoline.

Build-in Tank - Using a funnel, pour the correct amount of oil slowly with the gasoline as tank is filled.

Filling Oil Injection System

1. Check oil level using the sight gauge in front of the outboard.
2. Remove the fill cap and fill tank with oil.

	Capacity	Fluid Type
Oil tank	3.2 liters (96 fl. oz.)	Mercury or Quicksilver Premium 2-cycle TC-W3 outboard oil

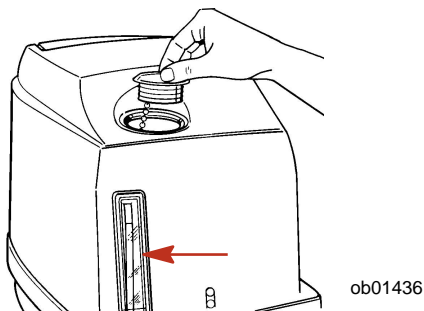

3. Reinstall fill cap and tighten securely.

Filling Fuel Tank

⚠ WARNING

Avoid serious injury or death from a gasoline fire or explosion. Always stop the engine and do not smoke or allow open flames or sparks in the area while filling fuel tanks.

Fill fuel tanks outdoors away from heat, sparks, and open flames.

Remove portable fuel tanks from boat to refill them.

Always stop engine before refilling tanks.

Do not completely fill the fuel tanks. Leave approximately 10% of the tank volume unfilled. Fuel will expand in volume as its temperature rises and can leak under pressure if the tank is completely filled.

PORTABLE FUEL TANK PLACEMENT IN THE BOAT

Place the fuel tank in the boat so the vent is higher than the fuel level under normal boat operating conditions.

FEATURES AND CONTROLS

Remote Control Features

Your boat may be equipped with one of the Mercury Precision or Quicksilver remote controls shown. If not, consult your dealer for a description of the functions and operations of the remote control.

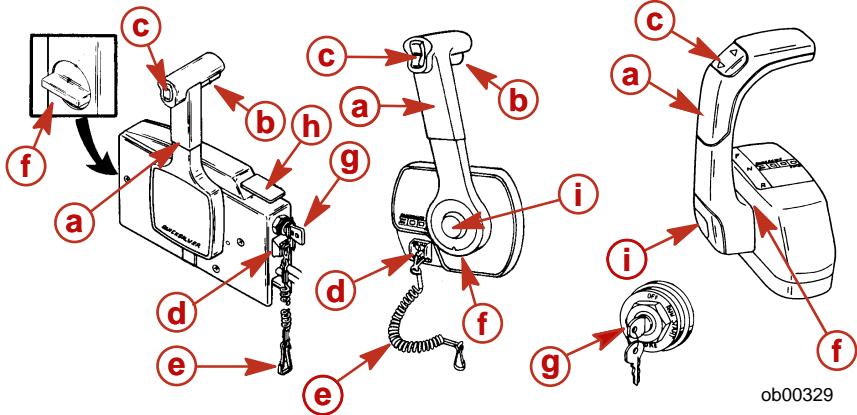

- a- Control handle - forward, neutral, reverse.
- b- Neutral release lever
- c- Trim/tilt switch (if equipped). - Refer to **Features & Controls - Power Trim and Tilt**.
- d- Lanyard stop switch - Refer to **General Information - Lanyard Stop Switch**.
- e- Lanyard - Refer to **General Information - Lanyard Stop Switch**.
- f- Throttle friction adjustment - Console controls require cover removal for adjustment.
- g- Ignition key switch - off, on, start.
- h- Fast idle lever - Refer to **Operation - Starting the Engine**.
- i- Throttle only button - Refer to **Operation - Starting the Engine**.

Warning System

The outboard warning system incorporates a warning horn inside the boat. Remote control models will have the warning horn located inside the remote control or connected to the ignition key switch.

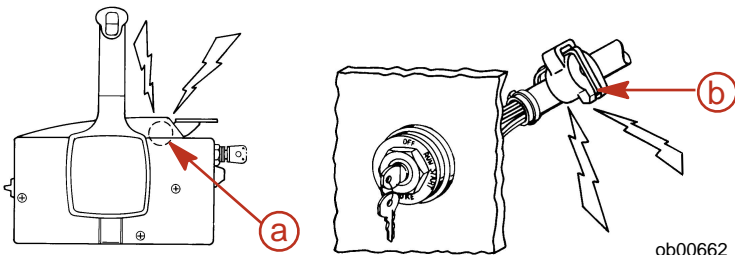

- a- Warning horn inside remote control
- b- Warning horn inside key switch

Tiller handle models will have the warning horn located below the tiller handle.

FEATURES AND CONTROLS

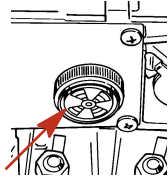

ob01437

WARNING SYSTEM OPERATION

The warning horn will emit a continuous beep. This will alert the operator and help identify the following listed situations.

Warning System		
Function	Sound	Description
Engine Over Temperature	Continuous	Engine Over Heat
Low Oil Level	Continuous	Low Oil Level

ENGINE OVERHEAT

If the engine overheats, immediately reduce throttle speed to idle. Shift outboard into neutral and check for a steady stream of water coming out of the water pump indicator hole.

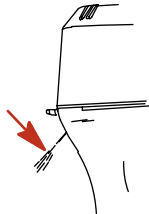

ob00331

If no water is coming out of the water pump indicator hole or flow is intermittent, stop engine and check the cooling water intake holes for obstruction. If no obstruction is found, there may be a blockage in the cooling system or a water pump problem. Have the outboard checked by your dealer. Operating the engine while overheated will cause engine damage.

NOTE: Should overheating occur and you are stranded, stop the engine and allow it to cool down. This will usually allow some additional low speed (idle) running time before the engine starts to overheat again. Operating an overheated engine will cause engine damage.

If a steady flow of water is coming out of the water pump indicator hole and the engine continues to overheat, consult your dealer. Operating an overheated engine will cause engine damage.

LOW OIL LEVEL

The warning system will be activated if the oil level drops below the sight gauge in the cowl when the outboard is in a vertical position. There is still oil reserve remaining for 30 minutes of full speed operation. Refer to **Fuel & Oil - Filling Oil Injection System**.

FEATURES AND CONTROLS

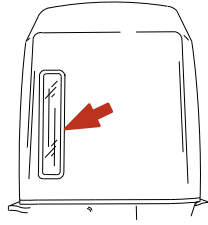

3103

Engine Over-Speed Limiter

The outboard is equipped with an engine over-speed limiter which limits the engine maximum RPM. This will protect the engine from mechanical damage.

Some causes of engine over-speed are as follows:

- Outboard mounted too high on the transom.
- Worn jet pump impeller or liner.
- Incorrect jet pump impeller clearance adjustment.
- Tilting the outboard out beyond a vertical position.
- Cavitation of the impeller due to rough water or obstruction in the boat hull.
- Blockage of the water intake.

When the engine over-speed limiter is activated, it will reduce ignition voltage to momentarily decrease the engine speed. Excessive over-speed (above 5700 RPM) will result in cutout of the cylinders to prevent operation above this limit.

Power Trim And Tilt

The outboard has a trim/tilt control called power trim. This enables the operator to easily adjust the position of the outboard by pressing the trim switch. Moving the outboard in closer to the boat transom is called trimming in or down. Moving the outboard further away from the boat transom is called trimming out or up. The term trim generally refers to the adjustment of the outboard within the first 20° range of travel. This is the range used while operating your boat on plane. The term tilt is generally used when referring to adjusting the outboard further up out of the water. With the engine turned off, the outboard can be tilted out of the water. At low speed, the outboard can also be tilted part the trim range to permit, for example, shallow water operation.

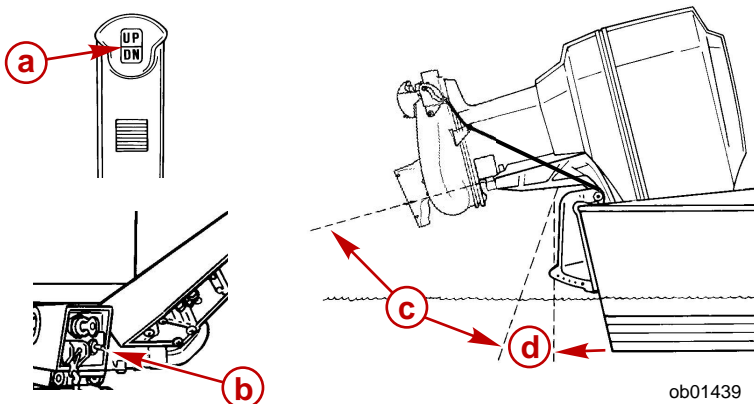

ob01439

- a** - Trim switch - remote control
- b** - Trim switch - tiller handle

- c** - Tilt range of travel
- d** - Trim range of travel

FEATURES AND CONTROLS

POWER TRIM OPERATION

The power trim and tilt feature of the outboard is convenient for drifting and when operating at low throttle speed in very shallow water. When under power, do not trim out the outboard in an effort to gain speed as is done with a conventional propeller driven boat.

When planing, the outboard should be positioned vertical or tilted in toward the boat to provide a scooping angle on the water intake grate. Tilting the outboard out beyond a vertical position reduces the scoop angle and can cause impeller slippage and cavitation burns on the impeller blades.

TILTING OPERATION

To tilt outboard, shut off the engine and press the trim/tilt switch or auxiliary tilt switch to the up position. The outboard will tilt up until the switch is released or it reaches its maximum tilt position.

1. Engage the tilt support lever, by rotating knob to bring the support lever upward.
2. Lower outboard to rest on the tilt support lever.
3. Disengage the tilt support lever, by raising the outboard off the support lever and rotating the lever down. Lower the outboard.

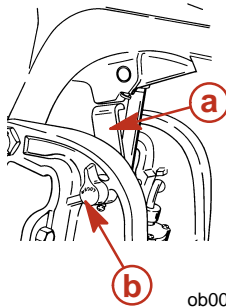

ob00336

a - Tilt support lever

b - Knob

MANUAL TILTING

If the outboard cannot be tilted using the power trim/tilt switch, the outboard can be manually tilted.

1. Turn out the manual tilt release valve 3 turns (counterclockwise). This allows manual tilting of the outboard.

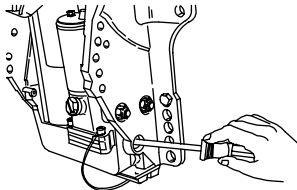

ob00339

NOTE: The manual tilt release valve must be tightened before operating the outboard to prevent the outboard from tilting up during reverse operation.

2. Tilt the outboard to the desired position and tighten the manual tilt release valve.

AUXILIARY TILT SWITCH

The auxiliary tilt switch can be used to tilt the outboard up or down using the power trim system.

FEATURES AND CONTROLS

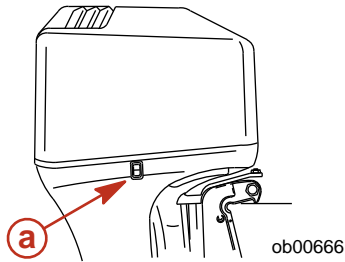

a - Auxiliary tilt switch

Manual Tilt System

Models without power trim are equipped with a tilt assist system that allows the operator to easily tilt and lock the outboard at any tilt position from full down to full up.

This tilt system is designed to be adjusted when the outboard is idling in neutral or with the engine turned off.

WARNING

Before operating, the outboard must be locked in its lock/run position. Failure to lock the outboard in its lock/run position could result in the outboard tilting up out of the water during deceleration or while operating in reverse, resulting in possible loss of boat control. Loss of boat control can result in serious injury, death, or boat damage.

Before operating, the outboard must be locked in its tilt position by moving the tilt lock lever to the lock/run position.

BASIC TILTING OPERATION

Move tilt lock lever to the tilt position. Tilt outboard to desired position and lock in place by moving the tilt lock lever back to the lock/run position.

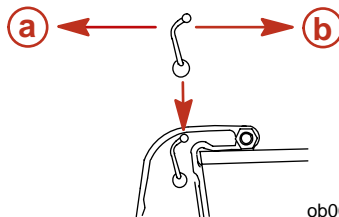

a - Tilt position

b - Lock/run position

SETTING THE OPERATING ANGLE OF THE OUTBOARD

The vertical operating angle of the outboard is adjusted by changing the position of the tilt pin in the adjustment holes provided. Proper adjustment allows the boat to achieve optimum performance, stability, and minimize steering effort.

FEATURES AND CONTROLS

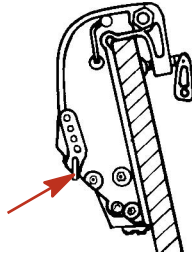

ob01440

The tilt pin should be adjusted so the outboard is positioned to run perpendicular to the water when the boat is running at full speed. This allows the boat to be driven parallel to the water.

Arrange passengers and load in the boat so the weight is distributed evenly.

TILTING OUTBOARD

Tilting To Full Up Position

1. Stop the engine. Move the tilt lock lever to the tilt position. Take hold of the top cowl grip and raise outboard to full tilt up position. Lock the outboard in place by moving the tilt lock lever to the lock/run position.

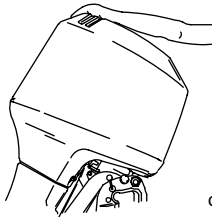

ob00335

2. Engage the tilt support lever by rotating knob to bring the tilt support lever upward.

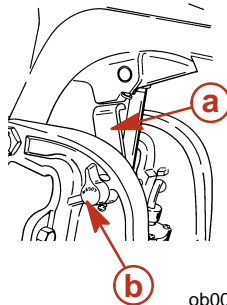

ob00336

a - Tilt support lever

b - Knob

3. Lower outboard to rest on the tilt support lever.

Lowering To Run Position

1. Disengage the tilt support lever by raising the outboard off the tilt support lever and rotating the lever down. Lower the outboard.
2. Move tilt lock lever to lock/run position.

FEATURES AND CONTROLS

Throttle Grip Friction Adjustment - Tiller Handle Models

Turn the wing nut to set and maintain the throttle at desired speed.

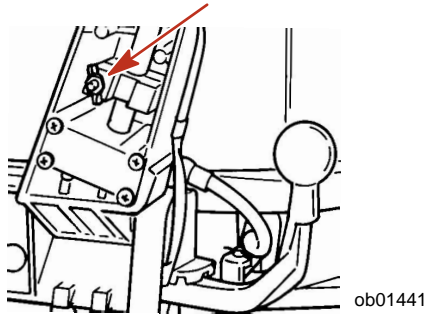

Steering Friction Adjustment - Tiller Handle Models

⚠ WARNING

Avoid possible serious injury or death from loss of boat control. Maintain sufficient steering friction to prevent the outboard from steering into a full turn if the tiller handle or steering wheel is released.

Adjust this lever to achieve the desired steering friction (drag) on the tiller handle.

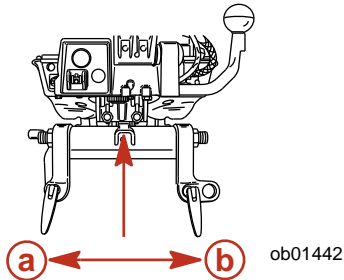

a - Tighten friction

b - Loosen friction

FEATURES AND CONTROLS

Replaceable Jet Drive Shear Key

The jet drive is equipped with a shear key to protect it in the event of a lodged impeller. The shear key can be reached by removing the water intake housing and impeller. Refer to **Maintenance - Impeller Removal and Installation**.

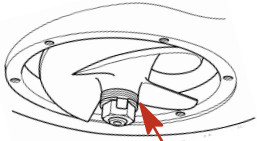

ob01443

OPERATION

Pre-Starting Check List

- Operator knows safe navigation, boating, and operating procedures.
- An approved personal flotation device of suitable size for each person aboard and readily accessible (it is the law).
- A ring type life buoy or buoyant cushion designed to be thrown to a person in the water.
- Know your boats maximum load capacity. Look at the boat capacity plate.
- Fuel supply OK.
- Oil supply (oil injection) OK.
- Ensure the boat drain plug is installed.
- Arrange passengers and load in the boat so the weight is distributed evenly and everyone is seated in a proper seat.
- Tell someone where you are going and when you expect to return.
- It is illegal to operate a boat while under the influence of alcohol or drugs.
- Know the waters and area you will be boating; tides, currents, sand bars, rocks, and other hazards.
- Make inspection checks listed in **Maintenance - Inspection and Maintenance Schedule**.
- Check steering for free operation.
- Check for debris around the rudder and reverse gate which may jam or hinder operation.
- Before launching, examine the jet drive water intake for obstructions which may prevent pumping of water.
- Ensure the driveshaft bearing on the jet drive is lubricated.

Operating In Freezing Temperatures

If there is a chance of ice forming on the water, the jet drive should be removed and drained completely of water. If ice should form at the water level inside the outboard driveshaft housing, it will block water flow to the engine causing possible damage. Do not start the engine until the ice is clear.

Operating In Salt Water Or Polluted Water

If the boat is kept moored in the water, always tilt the outboard so the water intake is completely out of water (except in freezing temperatures) when not in use.

Wash down the outboard exterior and flush out the exhaust outlet of the jet drive with fresh water after each use. Each month, spray Mercury Precision or Quicksilver Corrosion Guard on external metal surfaces.

NOTE: Do not spray on corrosion control anodes as this will reduce the effectiveness of the anodes.

Operating at High Elevations

IMPORTANT: To prevent serious damage to the engine caused by a lean fuel mixture, do not operate the outboard (if the jets were changed for high elevation) at a lower elevation unless the jets are changed again to correspond to the new elevation.

Operating the outboard at an elevation higher than 762 m (2500 ft.) above sea level may require a carburetor jet change. Consult your dealer. This will reduce the normal performance loss experienced as a result of reduced oxygen in the air causing an overly rich fuel mixture.

Operating In Shallow Water

The life of the impeller and water intake can be greatly increased by avoiding the intake of sand and gravel. The intake suction will act like a dredge when the water intake comes close to the bottom. It is better to stop the engine and drift up to shore when landing, and to shove off with an oar when leaving. The engine can idle through areas of water less than 61 cm (2 ft.) deep, but there should be more than 61 cm (2 ft.) of water under the boat when increasing speed to reach full plane.

Once the boat is on plane, the boat speed will prevent the ingestion of gravel and other debris from the bottom. The suction is still present, but the water intake passes too quickly over the bottom to allow debris to be drawn into the water intake.

OPERATION

When boating through shallow water areas, choose a course of travel that avoids sharp rocks and other underwater obstacles that could damage the boat. Running the boat through these areas on full plane may be helpful as the boat will be riding higher in the water. If the boat gets stuck on the bottom, immediately stop the engine and move the boat to deeper water.

How the Jet Drive Operates

A jet driven boat has substantially different handling characteristics compared to a propeller driven boat. It is recommended that the operator adjusts to these characteristics by experimenting in open water at both high and low speeds.

The driveshaft driven impeller draws water up through the water intake and then redirects it at a high pressure through the water outlet nozzle to create forward thrust. To obtain reverse, the reverse gate moves over the outlet nozzle to direct the water in the opposite direction.

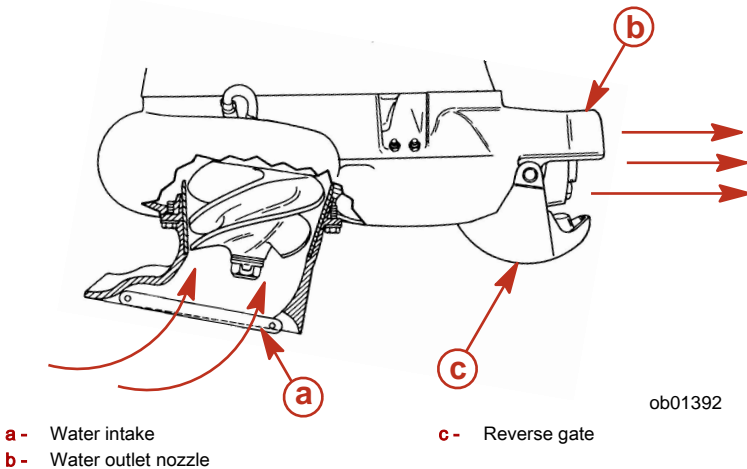

When the jet drive is in neutral, the impeller continues to rotate. However, the reverse gate is positioned so that some of the forward thrust is diverted to create reverse thrust. This approximate balancing of forward and reverse thrust will minimize any boat movement. Because the impeller is always rotating and creating thrust when the engine is running, the boat may tend to move slowly forward or backward. This is normal for a direct-drive jet driven boat. The operator should be aware of this and use caution whenever the engine is running.

! WARNING

Avoid injury resulting from contacting the rotating impeller or having hair, clothing or loose objects drawn into the water intake and wrapping around the impeller shaft. Stay away from the water intake and never insert an object into the water intake or water outlet nozzle when the engine is running.

The jet drive is always drawing water into the housing when the engine is running. Do not operate the jet drive with the grate removed from the water intake. Keep hands, feet, hair, loose clothing, life jackets, etc., away from the water intake. Never insert an object into the water intake or water outlet nozzle when the engine is running.

Stopping the Boat in an Emergency

A jet powered boat has emergency stopping capability unique to this form of propulsion.

OPERATION

WARNING

Using the emergency stopping capability of the jet drive will slow down the boat in an emergency. However, sudden stopping may cause the occupants in the boat to be thrown forward or even out of the boat. This action may result in serious injury or death.

In an emergency, putting the jet outboard into reverse and applying reverse throttle can rapidly slow down the boat and reduce stopping distance. However, such a maneuver may cause occupants in the boat to be thrown forward or possibly out of the boat.

Steering The Boat

The jet drive is dependent on water jet thrust for steering the boat. If the water jet thrust should ever stop, (water blockage, engine stops, etc.) the boat to slow to a stop. However, while slowing there will be a reduced ability to steer the boat.

WARNING

Avoid serious injury or death. Do not attempt to steer the boat into a tight turn. At high speeds, the boat could spin-out or even roll over, resulting in occupants being thrown within the boat or out of the boat.

WARNING

Avoid injury, death or property damage resulting from collision due to loss of directional control. Directional control is derived from the water jet thrust. Caution should be exercised when maneuvering at higher speeds in areas where debris (weeds, logs, gravel, etc.) could be picked up into the jet drive. This can cut off or reduce the water jet thrust, thereby directly affecting boat directional control. Boat directional control can also be substantially reduced or lost altogether by a sudden loss of power such as running out of gas, quickly backing off throttle, turning off ignition switch, or activating lanyard stop switch. Remember your ability to take evasive action is dependent on sufficient water jet thrust to control the boat.

While steering the boat at engine speeds above idle, the boat will respond quickly; but due to the relatively flat-bottom hulls and lack of a gearcase in the water, the boat will tend to skid on turns. Turns must be started early and use sufficient power to maintain steering control.

Mooring The Boat

Be sure to tilt the jet drive out of the water when the boat is pulled onto a beach or tied to a dock in shallow water. Failure to do this may cause the water intake housing to fill with sand or debris and could prevent the outboard from cranking over for starting.

Water Intake Blockage

WARNING

Avoid injury resulting from contacting the rotating impeller. Always shut off the engine before attempting to remove a blockage from the water intake.

A large amount of debris being drawn into the water intake may result in a loss of power. Intake suction holding debris against the grate will result in restricted water flow. Shutting the engine off may allow the debris to fall off the intake grate allowing full power to be restored. If debris does not fall off the intake grate, the engine must be shut off and debris physically removed from the grate.

OPERATION

Clearing A Lodged Impeller

⚠ WARNING

If the flywheel is rotated to free a lodged impeller, there is the possibility that the engine will crank over and start. To prevent this type of accidental engine starting and possible serious injury, always turn the ignition key or lanyard stop switch to the "OFF" position and remove all spark plug leads from the spark plugs.

It is possible for debris to lodge between the impeller and jet housing wall, especially after the engine has been stopped. This will lock the driveshaft and will prevent the engine from being able to crank over for starting. Following are steps for dislodging the impeller.

1. Position lanyard stop switch to the "OFF" position.
2. Remove spark plug leads to prevent the engine from accidentally starting.
3. Remove flywheel or rewind cover and rotate the engine flywheel counterclockwise.

If this does not dislodge the impeller, it will be necessary to remove the six screws and water intake housing.

Engine Break-in Procedure

⚠ CAUTION

Severe damage to the engine can result by not complying with the Engine Break-in Procedure.

ENGINE BREAK-IN FUEL MIXTURE

Use a 50:1 (2%) gasoline/oil mixture in the first tank of fuel. Refer to the following table for mixing ratios. Use of this fuel mixture combined with oil from the oil injection system will supply adequate lubrication during engine break-in.

BREAK-IN PROCEDURE

Vary the throttle setting during the first hour of operation. During the first hour of operation, avoid remaining at a constant speed for more than two minutes and avoid sustained wide open throttle.

Starting The Engine

Before starting, read the Pre-Starting Check List, Special Operating Instructions, and Engine Break-in Procedure in the Operation section.

⚠ CAUTION

Never start or operate your outboard (even momentarily) without water circulating through all the cooling water intake holes in the gearcase to prevent damage to the water pump (running dry) or overheating of the engine.

1. Ensure the driveshaft bearing on the jet drive is lubricated. Refer to **Maintenance - Lubrication Points**.

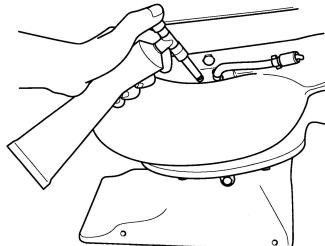

2. Open fuel tank vent screw (in filler cap) on manual venting type fuel tanks.

OPERATION

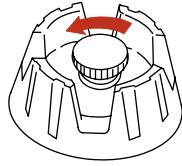

ob00348

3. Connect the fuel line to the outboard.

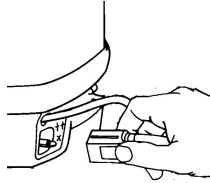

ob01445

4. Squeeze the fuel line primer bulb several times until it feels firm.

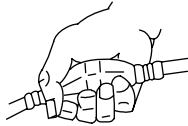

ob00349

NOTE: The engine will not start unless the lanyard is set to the "RUN" position.

5. Set the lanyard stop switch to the "RUN" position. Refer to **General Information - Lanyard Stop Switch**.



ob00350

6. Shift outboard to neutral (N) position.

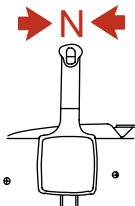

ob00351

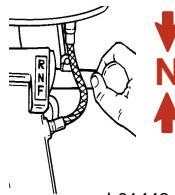

ob01446

7. Models without power trim - Position tilt lock lever to the lock position.

OPERATION

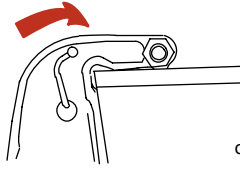

8. Tiller handle models - Align the throttle grip pointer to the "START" position.

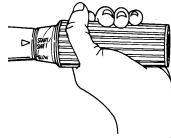

9. Remote control models - If engine is cold, advance the fast idle speed lever of throttle only feature to an approximate halfway setting. After engine start up, immediately adjust neutral fast idle setting so engine speed drops below 2000 RPM. Return back to normal idle speed after engine is warmed up.

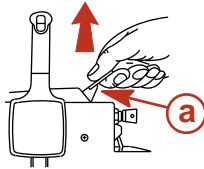

a - Fast idle speed lever

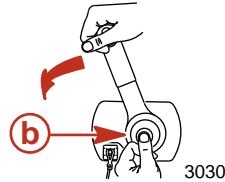

b - Throttle only feature

10. Starting a flooded engine:
- Tiller handle models - Advance the throttle grip to full throttle speed. Without activating primer, start engine following starting procedure. Immediately start to reduce engine speed after engine starts.
 - Remote control models - Advance the fast idle speed lever or throttle only feature to the full maximum position. Without activating the primer, crank engine for 10 seconds. Wait 30 seconds and repeat until engine starts. Immediately start to reduce engine speed after engine starts.
11. Turn ignition key to "START" position and start the engine. If engine is cold, push in on key to prime the engine while cranking. If engine fails to start in ten seconds, wait 30 seconds and try again. If engine begins to stall, reprime until engine is running smoothly.

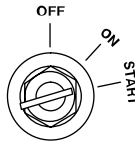

12. After engine starts, check for a steady stream of water flowing out of the water pump indicator hole.



OPERATION

IMPORTANT: If no water is coming out of the water pump indicator hole, stop engine and check cooling water intake for obstruction. No obstruction may indicate a water pump failure or blockage in the cooling system. These conditions will cause the engine to overheat. Have the outboard checked by your dealer. Operating the engine while overheated may cause serious engine damage.

Gear Shifting

- The outboard has three gear shift positions to provide operation. Forward (F), Neutral (N) and Reverse (R).

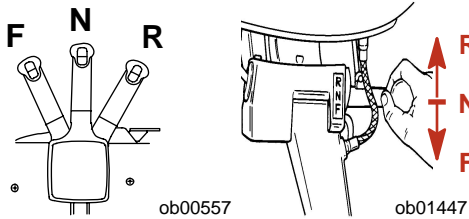

- Tiller handle models - Reduce engine speed to idle before shifting.

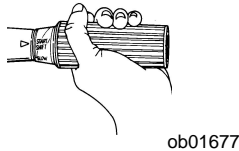

- After shifting outboard into gear, advance the remote control lever or rotate the throttle grip (tiller handle) to increase speed.

Stopping The Engine

- Remote Control Models** - Reduce engine speed and shift outboard to neutral position. Turn ignition key to "OFF" position.

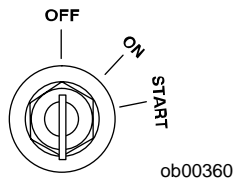

- Tiller Handle Models** - Reduce engine speed and shift outboard to neutral position. Push in the engine stop button or turn ignition key to "OFF" position.

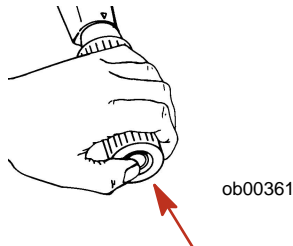

OPERATION

Emergency Starting

If the starter system fails, use the spare starter rope (provided) and follow procedure.

1. Remove flywheel cover.

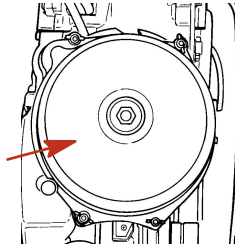

ob01448

WARNING

When using emergency starter rope to start engine, the start in gear protection device is inoperative. Make sure to set the outboard gear shift into neutral (N) position to prevent outboard from starting in gear. Sudden unexpected acceleration could result in serious injury or death.

2. Shift outboard to neutral (N) position.

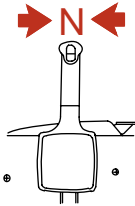

ob00351

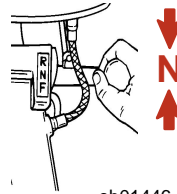

ob01446

3. Turn the ignition key to "ON" position.

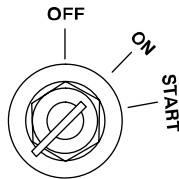

ob00364

4. Set the lanyard stop switch to the "RUN" position. Refer to **General Information - Lanyard Stop Switch**.



ob00350

OPERATION

⚠ WARNING

To prevent getting an electrical shock, do not touch any ignition component, wiring, or spark plug wire when starting or running the engine.

⚠ WARNING

The exposed moving flywheel can cause serious injury. Keep your hands, hair, clothing, tools, and other objects away from engine when starting or running the engine. Do not attempt to reinstall the flywheel cover or top cowl when engine is running.

5. Place starter rope knot into the flywheel notch and wind the rope clockwise around the flywheel.

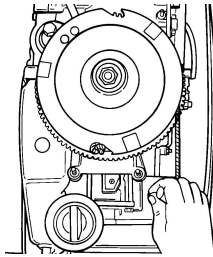

ob01449

6. If engine is cold, hold the fuel primer button in and pump up the fuel pressure with the fuel primer bulb.

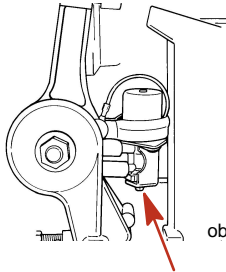

ob01649

7. Pull the starter rope to start the engine.

MAINTENANCE

Outboard Care

To keep your outboard in the best operating condition, it is important that your outboard receive the periodic inspections and maintenance listed in the Inspection and Maintenance Schedule. We urge you to keep it maintained properly to ensure the safety of you and your passengers, and retain its dependability.

⚠ WARNING

Neglected inspection and maintenance service of your outboard or attempting to perform maintenance or repair on your outboard if you are not familiar with the correct service and safety procedures could cause personal injury, death, or product failure.

Record maintenance performed in Maintenance Log at the back of this book. Save all maintenance work orders and receipts.

SELECTING REPLACEMENT PARTS FOR YOUR OUTBOARD

We recommend using original Mercury Precision or Quicksilver replacement parts and Genuine Lubricants.

⚠ WARNING

Using a replacement part that is inferior to the original part could result in personal injury, death, or product failure.

EPA Emissions

EMISSION CERTIFICATION LABEL

An emission certification label, showing emission levels and engine specifications directly related to emissions, is placed on the engine at time of manufacture.

		EMISSION CONTROL INFORMATION	
This engine conforms to <input type="checkbox"/> model year EPA regulations for Marine SI engines. Refer to Owner's Manual for required maintenance.			
a	IDLE SPEED: <input type="text"/>	FAMILY: <input type="text"/>	f
b	<input type="text"/> hp	<input type="text"/> cc	g
c	TIMING (IN DEGREES): <input type="text"/>	FEL: <input type="text"/> g/kWh	h
d	Standard spark plug: <input type="text"/>	<input type="text"/>	i
	Suppressor spark plug: <input type="text"/>		
	GAP: <input type="text"/>		
e	Valve Clearance (Cold) mm	Intake <input type="text"/>	
		Exhaust <input type="text"/>	

ob01071

- a** - Idle speed
- b** - Engine horsepower
- c** - Timing specification
- d** - Recommended spark plug and gap
- e** - Valve clearance (if applicable)
- f** - Family number
- g** - Maximum emission output for the engine family
- h** - Piston placement
- i** - Date of manufacture

OWNER RESPONSIBILITY

The owner/operator is required to have routine engine maintenance performed to maintain emission levels within prescribed certification standards.

The owner/operator is not to modify the engine in any manner that would alter the horsepower or allow emissions levels to exceed their predetermined factory specifications.

MAINTENANCE

Inspection And Maintenance Schedule

BEFORE EACH USE

- Check that lanyard stop switch stops the engine.
- Visually inspect the fuel system for deterioration or leaks.
- Check outboard for tightness on transom.
- Check throttle, shift, steering system for binding or loose components.
- Remote control models - Visually check steering link rod fasteners for proper tightness. See **Steering Link Rod Fasteners**.
- Make sure the driveshaft bearing on the jet drive is lubricated. See **Lubrication Points**.

AFTER EACH USE AND AFTER EVERY 10 HOURS OF OPERATION

- Lubricate the driveshaft bearing on the jet drive. See **Lubrication Points**.

AFTER EACH USE

- Flush out the outboard cooling system if operating in salt or polluted water. See **Flushing The Cooling System**.
- If operating in salt water, wash off all salt deposits and flush out exhaust outlet on the jet drive with fresh water.

EVERY 100 HOURS OF USE OR ONCE YEARLY, WHICHEVER OCCURS FIRST

- Lubricate all lubrication points. Lubricate more frequently when used in salt water. See **Lubrication Points**.
- Inspect and clean spark plugs. See **Spark Plug Inspection and Replacement**.
- Check engine fuel filter for contaminants. See **Fuel System**.
- Check carburetor adjustments, if required. ¹
- Check engine timing setup. ¹
- Lubricate splines on the driveshaft. ¹
- Check corrosion control anode. Check more frequently when used in salt water. See **Corrosion Control Anode**.
- Check power trim fluid.
- Inspect battery. See **Battery Inspection**.
- Remote control models - Check control cable adjustments. ¹
- Remove engine deposits with Quicksilver or Mercury Precision Power Tune Engine Cleaner.
- Check tightness of bolts, nuts, and other fasteners.

EVERY 300 HOURS OF USE OR THREE YEARS

- Replace water pump impeller (more often if overheating occurs or reduced water pressure is noted.) ¹

BEFORE PERIODS OF STORAGE

- Refer to Storage procedure. See **Storage** section.

Flushing The Cooling System

Flush the internal water passages of the outboard with fresh water after each use in salt, polluted, or muddy water. This will help prevent a buildup of deposits from clogging the internal water passages.

Use a Mercury Precision Parts or Quicksilver accessory hose coupling.

1. Remove plug and gasket.
2. Thread in hose coupling.

1. These items should be serviced by an authorized dealer.

MAINTENANCE

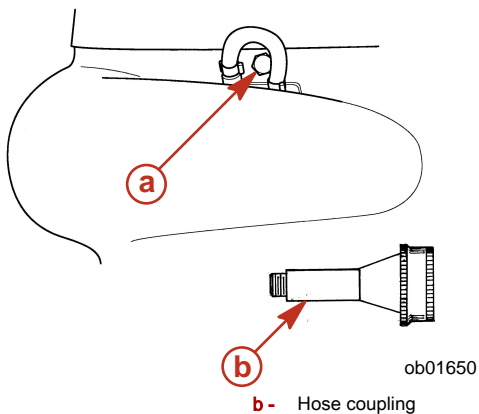

a - Plug and gasket

b - Hose coupling

3. Attach a water hose to the hose coupling. Slowly turn on water. Start the engine and run it at idle speed only.

IMPORTANT: Do not run engine above idle when flushing.

4. Check for a steady stream of water flowing out of the water pump indicator hole. Continue flushing the outboard for 3 to 5 minutes, carefully monitoring water supply at all times.

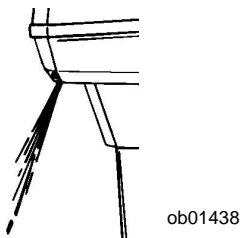

5. Stop the engine, turn off the water, and remove the hose coupling. Reinstall plug and gasket.

Top Cowl Removal And Installation

REMOVAL

1. Unlock the rear latch by pushing lever down.

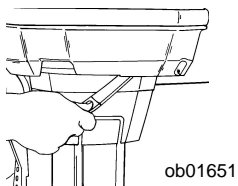

2. Lift rear of cowl and disengage front hook.

MAINTENANCE

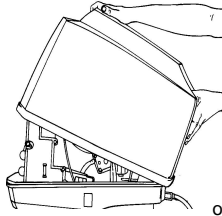

ob01652

INSTALLATION

1. Engage the front hook and push cowl back over the cowl seal.
2. Push cowl down and move the rear latch lever up to lock.

Battery Inspection

The battery should be inspected at periodic intervals to ensure proper engine starting capability.

IMPORTANT: Read the safety and maintenance instructions which accompany your battery.

1. Turn off the engine before servicing the battery.
2. Add water as necessary to keep the battery full.
3. Make sure the battery is secure against movement.
4. Battery cable terminals should be clean, tight, and correctly installed. Positive to positive and negative to negative.
5. Make sure the battery is equipped with a nonconductive shield to prevent accidental shorting of battery terminals.

Fuel System

WARNING

Avoid serious injury or death from gasoline fire or explosion. Carefully follow all fuel system service instructions. Always stop the engine and do not smoke or allow open flames or sparks in the area while servicing any part of the fuel system.

Before servicing any part of the fuel system, stop engine and disconnect the battery. Drain the fuel system completely. Use an approved container to collect and store fuel. Wipe up any spillage immediately. Material used to contain spillage must be disposed of in an approved receptacle. Any fuel system service must be performed in a well ventilated area. Inspect any completed service work for sign of fuel leakage.

FUEL LINE FILTER

Inspect the fuel line filter. If the filter appears to be contaminated, remove and replace.

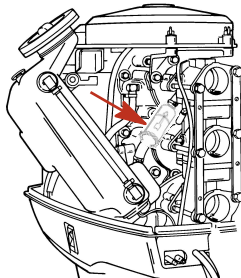

ob01653

MAINTENANCE

IMPORTANT: Visually inspect for fuel leakage from the filter connections by squeezing the primer bulb until firm, forcing fuel into the filter.

FUEL LINE INSPECTION

Visually inspect the fuel line and primer bulb for cracks, swelling, leaks, hardness, or other signs of deterioration or damage. If any of these conditions are found, the fuel line or primer bulb must be replaced.

Exterior Care

Your outboard is protected with a durable baked enamel finish. Clean and wax often using marine cleaners and waxes.

Steering Link Rod Fasteners

IMPORTANT: The steering link rod that connects the steering cable to the engine must be fastened using special washer head bolt ("d" - Part Number 10-856680) and self-locking nylon insert locknuts ("a" & "c" - Part Number 11-826709113). These locknuts must never be replaced with common nuts (non-locking) as they will work loose and vibrate off, freeing the link rod to disengage.

⚠ WARNING

Disengagement of a steering link rod can result in the boat taking a full, sudden, sharp turn. This potentially violent action can cause occupants to be thrown overboard exposing them to serious injury or death.

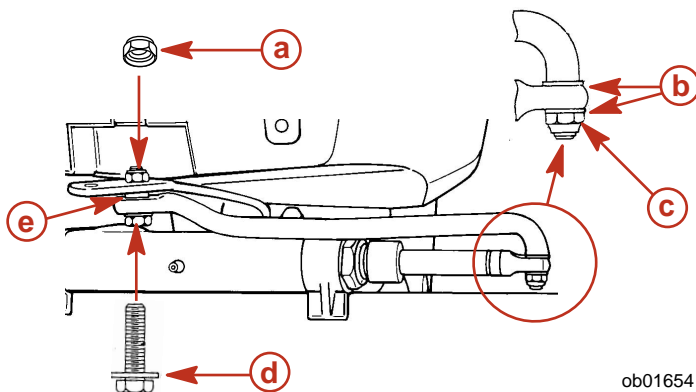

ob01654

- a - Nylon insert locknut (11-826709113)
- b - Flat washers
- c - Nylon insert locknut (11-826709113)
- d - Special washer head bolt (10-856680)
- e - Spacer

Description	Nm	lb. in.	lb. ft.
Special washer head bolt	27		20
Nylon insert locknut "a"	27		20
Nylon insert locknut "c"	Tighten until seats, then back off 1/4 turn		

MAINTENANCE

Assemble steering link rod to steering cable with two flat washers and nylon insert locknut. Tighten locknut until it seats, then back nut off 1/4 turn.

Assemble steering link rod to engine with special washer head bolt, locknut and spacer. First torque special washer head bolt, then torque locknut to specifications.

Fuse Replacement

IMPORTANT: Always carry spare SFE 20 AMP fuses.

The electric starting circuit is protected from overload by an SFE 20 AMP fuse. If the fuse is blown, the electric starter motor will not operate. Try to locate and correct the cause of the overload. If the cause is not found, the fuse may blow again. Replace fuse with a fuse of the same rating

1. Open the fuse holder and look at the silver colored band inside the fuse. If band is broken, replace the fuse with a new fuse with the same rating.

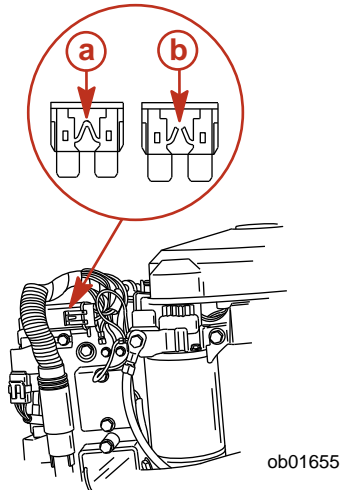

a- Good fuse

b- Broken band

Corrosion Control Anode

The outboard has corrosion control anode installed on the bottom of the transom bracket assembly. An anode helps protect the outboard against galvanic corrosion by sacrificing its metal to be slowly corroded instead of the outboard metals.

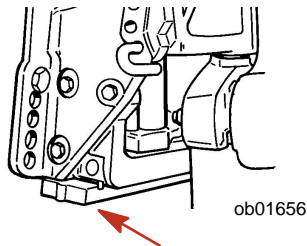

The anode requires periodic inspection, especially in salt water which will accelerate the erosion. To maintain this corrosion protection, always replace the anode before it is completely eroded. Never paint or apply a protective coating on the anode as this will reduce effectiveness of the anode.

MAINTENANCE

Spark Plug Inspection and Replacement

WARNING

Avoid serious injury or death from fire or explosion caused by damaged spark plug boots. Damaged spark plug boots can emit sparks. Sparks can ignite fuel vapors under the engine cowl. To avoid damaging spark plug boots, do not use any sharp object or metal tool such as pliers, screwdriver, etc. to remove spark plug boots.

1. Remove the spark plug leads. Twist the rubber boots slightly and pull off.

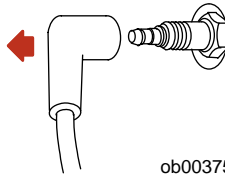

ob00375

2. Remove the spark plugs to inspect. Replace spark plug if electrode is worn or the insulator is rough, cracked, broken, blistered or fouled.

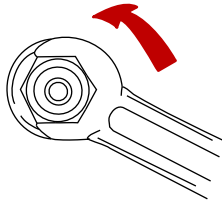

ob01092

3. Set the spark plug gap to specifications.

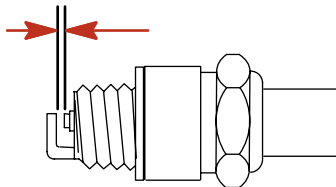

ob00424

Spark Plug

Spark plug gap

1.0 mm (0.040 in.)

4. Before installing spark plugs, clean off any dirt on the spark plug seats. Install plugs finger tight, and then tighten 1/4 turn or torque to specifications.

Description	Nm	lb. in.	lb. ft.
Spark plug	27		20

Steering Pull Adjustment

The steering on some boats will have the tendency to pull towards starboard. This pulling condition can be corrected by using a pliers and bending the ends of the exhaust fins 1.5 mm (1/16 in.) toward the starboard side of the outboard.

MAINTENANCE

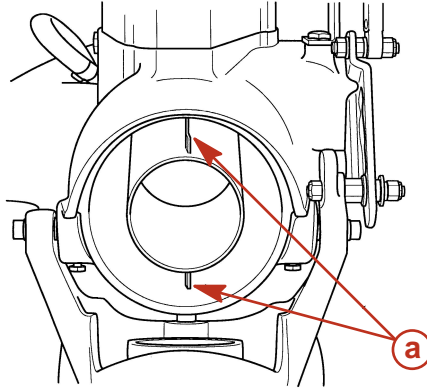

a - Exhaust fins

Worn/Dull Impeller

The intake of gravel through the pump can round off and wear the leading edges of the impeller. Some conditions that could be experienced from a worn/dull impeller are as follows:

- Noticeable performance loss, especially on acceleration
- Difficulty getting the boat on plane
- An increase in engine RPM at wide open throttle

IMPORTANT: Do not sharpen or alter the top side lifting angle.

Check the impeller blades occasionally for damage. Use a flat file to resharpen the leading edges. Sharpen to a 0.8 mm (1/32 in.) radius by removing material from bottom side only.

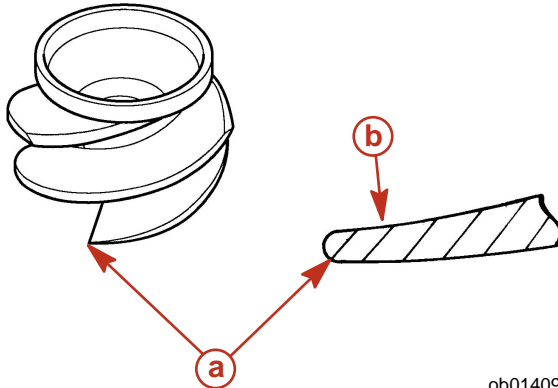

a - Leading edge

b - Top side lifting angle

Impeller Clearance Adjustment

The impeller should be adjusted so there is approximately 0.8 mm (0.03 in.) clearance between the impeller edge and liner. Operating the jet drive in waters that contain sand and gravel can cause wear to the impeller blades, and the clearance will start to exceed 0.8 mm (0.03 in.).

MAINTENANCE

As the blades wear, shims located in the stack outside of the impeller can be transferred behind the impeller. This will move the impeller further down into the tapered liner to reduce the clearance.

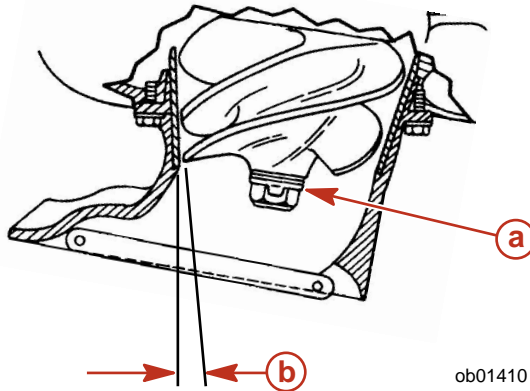

ob01410

- a - Shims
- b - Clearance between impeller edge and liner

Check the impeller clearance by sliding a feeler gauge through the intake grate and measure the clearance between the impeller edge and liner. If adjustment is required, refer to **Impeller Removal and Installation**.

Impeller Removal and Installation

⚠ WARNING

If the driveshaft is rotated while the engine is in gear, there is the possibility that the engine will crank over and start. To prevent this type of accidental engine starting and possible serious injury caused from being struck by a rotating impeller, always shift outboard to neutral position and remove spark plug leads when servicing the propeller.

REMOVAL

1. Shift outboard to neutral (N) position.

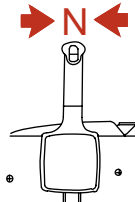

ob00351

2. Remove spark plug leads to prevent engine from starting.

MAINTENANCE

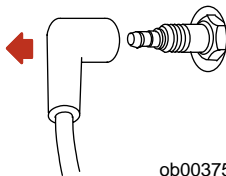

3. Remove the water intake housing that is fastened with six screws.

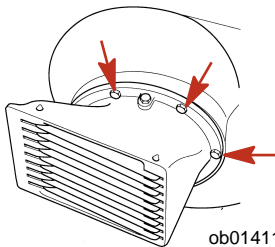

4. Straighten the bent tabs on the impeller nut retainer and remove the impeller nut.

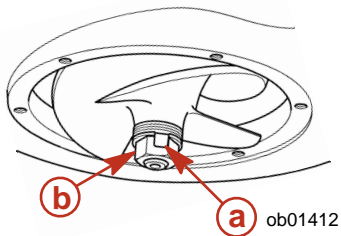

a - Tabs

b - Impeller nut

5. Pull impeller straight off the shaft. If the impeller is tight, use a hammer and block of wood to rotate the impeller clockwise on the shaft until the keyway is directly above the flat on the shaft. This will free the jammed key and allow removal.

INSTALLATION

1. Grease the driveshaft, shear key, and impeller bore.
2. Place the plastic sleeve inside the impeller.
3. Install impeller, shear key, shims, nut retainer, and impeller nut.

MAINTENANCE

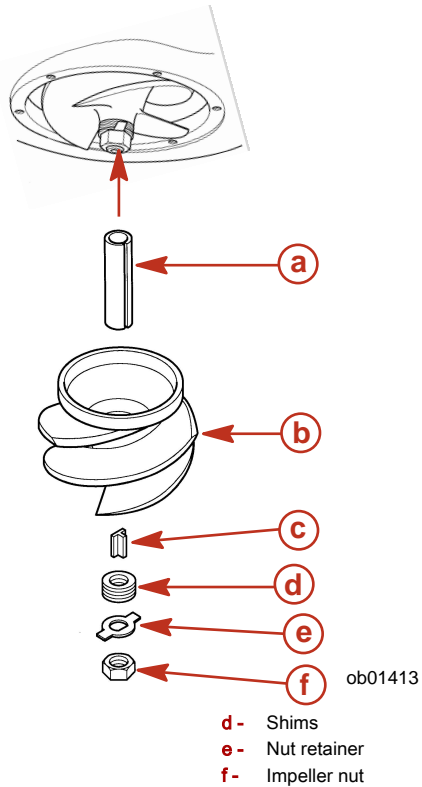

4. Turn the nut tight on the shaft to remove any play between the impeller and shaft. If the tabs on the retainer do not line up with the flats on the nut, remove the nut and turn the retainer over and re-tighten the nut again.
5. Temporarily reinstall the water intake housing in order to check for impeller clearance. The clearance between the impeller and liner should be 0.08 mm (0.03 in.). Shim washers can be transferred to either side of the impeller to raise or lower the impeller to the correct clearance setting. The water intake housing can be shifted sideways a small amount in order to center the liner.

MAINTENANCE

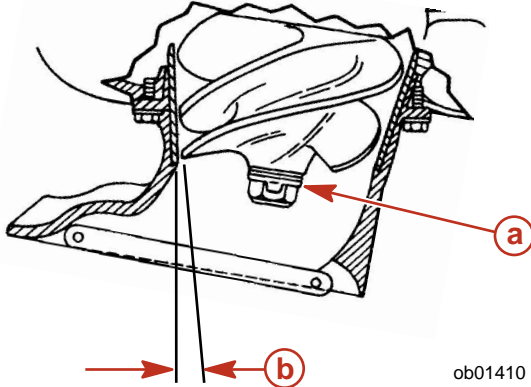

ob01410

a- Shims

b- Clearance between impeller edge and liner

6. After setting the impeller height, tighten the impeller nut snug with a wrench. Secure impeller nut by bending tabs against the flat on the impeller nut.

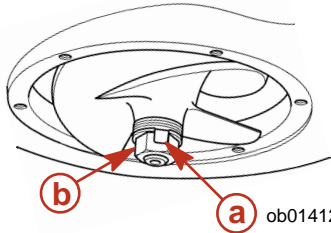

ob01412

a- Tabs

b- Impeller nut

NOTE: If the outboard is used in salt water, apply Quicksilver or Mercury Precision Anti-Corrosion Grease around the entire mounting flange on the water intake housing and also to the threads on the six mounting bolts.

7. Reinstall the water intake housing with six bolts. Check clearance around the impeller to ensure the water intake housing is centered and not rubbing against the liner. Torque mounting bolts to specifications.

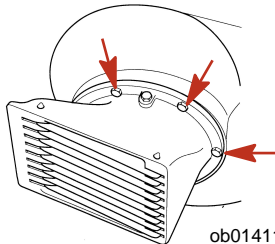

ob01411

MAINTENANCE

Description	Nm	lb. in.	lb. ft.
Water intake housing mounting bolts	13	120	

Lubrication Points

1. Lubricate the following with Quicksilver or Mercury Precision 2-4-C with Teflon.

IMPORTANT: It is important not to use a general all purpose grease for this bearing. The lubricant recommended is a water resistant grease of the proper consistency for this application. If a substitute is used, be sure that it is water resistant and of the same consistency.

- Driveshaft Bearing
 - i. Pull vent hose off of the grease fitting.
 - ii. Pump in grease through the great fitting, using the grease gun provided, until excess grease starts to exit the vent hose.
 - iii. Reconnect the vent hose onto the grease fitting after greasing.

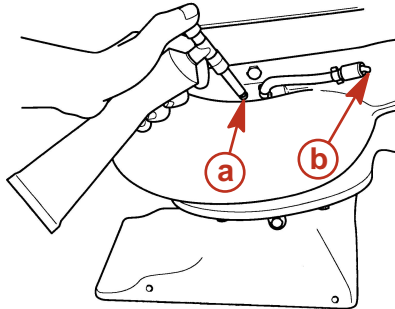

ob01416

a- Grease fitting

b- Vent hose

NOTE: After 30 hours of operation, pump in extra grease to purge out any moisture. Visually inspecting the purged grease at this time will give an indication of conditions inside the bearing housing. A gradual increase in moisture content, indicates seal wear. If the grease begins to turn dark, dirty gray, the driveshaft bearing and seals should be inspected and replaced if necessary. Some discoloration of the grease is normal during the break-in period on a new set of seals.

2. Lubricate the following with Quicksilver or Mercury Precision Lubricants 2-4-C Marine Lubricant with Teflon or Special Lubricant 101.

- Swivel Bracket - Lubricate through fitting.
- Tilt Support Lever - Lubricate through fitting.

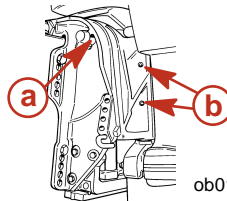

ob01658

a- Tilt support lever

b- Swivel bracket

- Tilt Tube - Lubricate through fitting.

MAINTENANCE

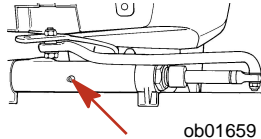

ob01659

- Tiller handle - Lubricate through fitting.

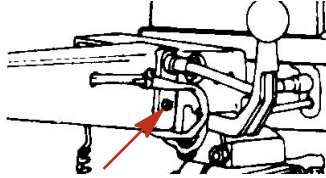

ob01660

- Steering Cable - Rotate steering wheel to fully retract the steering cable end into the outboard tilt tube. Lubricate through fitting.

WARNING

The end of the steering cable must be fully retracted into the outboard tilt tube before adding lubricant. Adding lubricant to steering cable when fully extended could cause steering cable to become hydraulically locked. A hydraulically locked steering cable will cause loss of steering control, possibly resulting in serious injury or death.

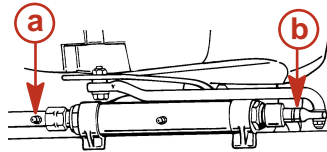

ob01661

a- Fitting

b- Steering cable end

3. Lubricate the following with light weight oil
 - Steering Link Rod Pivot Points - Lubricate pivot points.

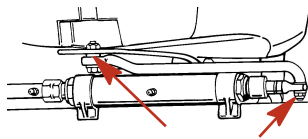

ob01662

Checking Power Trim Fluid

1. Tilt outboard to the full up position and engage the tilt support lock.

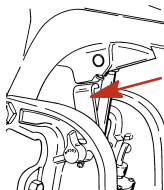

ob00434

MAINTENANCE

2. Remove fill cap and check fluid level. The fluid level should be even with the bottom of the fill hole. Add Quicksilver or Mercury Precision Lubricants Power Trim & Steering Fluid. If not available, use automotive (ATF) automatic transmission fluid.

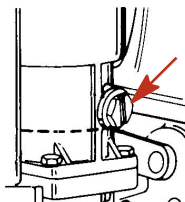

ob01663

Submerged Outboard

A submerged outboard will require service within a few hours by an authorized dealer once the outboard is recovered from the water. This immediate attention by a servicing dealer is necessary once the engine is exposed to the atmosphere to minimize internal corrosion damage to the engine.

STORAGE

Storage Preparation

The major consideration in preparing the outboard for storage is to protect it from rust, corrosion, and damage caused by freezing of trapped water.

The following storage procedures should be followed to prepare outboard for out of season storage or prolonged storage (two months or longer).

FUEL SYSTEM

IMPORTANT: Gasoline containing alcohol (ethanol or methanol) can cause a formation of acid during storage and can damage the fuel system. If the gasoline being used contains alcohol, it is advisable to drain as much of the remaining gasoline as possible from the fuel tank, remote fuel line, and engine fuel system.

Fill the fuel tank and engine fuel system with treated (stabilized) fuel to help prevent formation of varnish and gum. Proceed with following instructions.

- **Portable Fuel Tank** - Pour the required amount of gasoline stabilizer (follow instructions on container) into fuel tank. Tip fuel tank back and forth to mix stabilizer with the fuel.
- **Permanently Installed Fuel Tank** - Pour the required amount of gasoline stabilizer (follow instructions on container) into a separate container and mix with approximately one quart (one liter) of gasoline. Pour this mixture into fuel tank.
- Place the outboard in water or connect flushing attachment for circulating cooling water. Run the engine for ten minutes to fill the engine fuel system.

Protecting External Outboard Components

- Lubricate all outboard components listed in **Maintenance - Inspection and Maintenance Schedule**.
- Touch up any paint nicks. See your dealer for touch-up paint.
- Spray Quicksilver or Mercury Precision Lubricants Corrosion Guard on external metal surfaces (except corrosion control anodes).

Protecting Internal Engine Components

NOTE: Make sure the fuel system has been prepared for storage. Refer to *Fuel System*, preceding.

IMPORTANT: Refer to Maintenance - Spark Plug Inspection and Replacement for correct procedure for removing spark plug boots.

- Place the outboard in water or connect flushing attachment for circulating cooling water. Start the engine and let it run in neutral to warm up.
- With engine running at fast idle, stop the fuel flow by disconnecting the remote fuel line. When engine begins to stall, quickly spray Quicksilver or Mercury Precision Lubricants Storage Seal into carburetor until engine stops from lack of fuel.
- Remove the spark plugs and inject a five second spray of storage seal around the inside of the cylinder.
- Rotate the flywheel manually several times to distribute the storage seal in the cylinder. Reinstall spark plug.

Jet Drive

- Pump extra grease into the jet drive bearing to purge out moisture.

Positioning Outboard for Storage

Store the outboard in an upright (vertical) position. This will allow water to drain out of the outboard.

Battery Storage

- Follow the battery manufacturer's instructions for storage and recharging.
- Remove the battery from the boat and check water level. Recharge if necessary.
- Store the battery in a cool, dry place.
- Periodically check the water level and recharge the battery during storage.

TROUBLESHOOTING

Starter Motor Will Not Crank The Engine (Electric Start Models)

POSSIBLE CAUSES

- Remote control models - Blown 20 Amp fuse in the starting circuit. Refer to **Maintenance** section.
- Outboard is not shifted to neutral position.
- Weak battery or battery connections are loose or corroded.
- Ignition key switch failure.
- Wiring or electrical connection faulty.
- Starter motor or starter solenoid failure.

Engine Will Not Start

POSSIBLE CAUSES

- Lanyard stop switch not in "RUN" position.
- Incorrect starting procedure. Refer to **Operation** section.
- Old or contaminated gasoline.
- Engine flooded. Refer to **Operation** section.
- Fuel is not reaching the engine.
 - a. Fuel tank is empty.
 - b. Fuel tank vent not open or restricted.
 - c. Fuel line is disconnected or kinked.
 - d. Primer bulb not squeezed.
 - e. Primer bulb check valve is faulty.
 - f. Fuel filter is obstructed. Refer to **Maintenance** section.
 - g. Fuel pump failure.
 - h. Fuel tank filter obstructed.
- Ignition system component failure.
- Spark plugs fouled or defective. Refer to **Maintenance** section.

Engine Runs Erratically

POSSIBLE CAUSES

- Spark plugs fouled or defective. Refer to **Maintenance** section.
- Incorrect setup and adjustments.
- Fuel is being restricted to the engine.
 - Engine fuel filter is obstructed. Refer to **Maintenance** section.
 - Fuel tank filter obstructed.
 - Stuck anti-siphon valve on built in fuel tank.
 - Fuel line is kinked or pinched.
- Fuel pump failure.
- Ignition system component failure.

Engine Over-Speed (Excessive RPM)

POSSIBLE CAUSES

- Outboard mounted too high on the transom.
- Worn jet pump impeller or liner.
- Incorrect jet pump impeller clearance adjustment.
- Tilting the outboard out beyond a vertical position.

TROUBLESHOOTING

- Cavitation of the impeller due to rough water or obstruction in the boat hull.
- Blockage of the water intake.

Performance Loss

POSSIBLE CAUSES

- Throttle not fully open.
- Damaged impeller.
- Incorrect engine timing, adjustments, or setup.
- Boat overloaded or load improperly distributed.
- Excessive water in bilge.
- Boat bottom is dirty or damaged.

Battery Will Not Hold Charge

POSSIBLE CAUSES

- Battery connections are loose or corroded.
- Low electrolyte level in battery.
- Worn out or inefficient battery.
- Excessive use of electrical accessories.
- Defective rectifier, alternator, or voltage regulator.

OWNER SERVICE ASSISTANCE

Local Repair Service

Always return your outboard to your local authorized dealer should the need for service arise. Only he has the factory trained mechanics, knowledge, special tools, equipment, and genuine parts and accessories to properly service your engine should the need occur. He knows your engine best.

Service Away From Home

If you are away from your local dealer and the need arises for service, contact the nearest authorized dealer. Refer to the Yellow Pages of the telephone directory. If, for any reason, you cannot obtain service, contact the nearest Mercury Marine Service Office.

Parts And Accessories Inquiries

All inquiries concerning genuine replacement parts and accessories should be directed to your local authorized dealer. The dealer has the necessary information to order parts and accessories for you. When inquiring on parts and accessories, the dealer requires the model and serial number to order the correct parts.

Service Assistance

Your satisfaction with your outboard product is very important to your dealer and to us. If you ever have a problem, question or concern about your outboard product, contact your dealer or any authorized Mercury Marine dealership. If additional assistance is required, take these steps.

1. Talk with the dealership's sales manager or service manager. If this has already been done, then contact the owner of the dealership.
2. Should you have a question, concern, or problem that cannot be resolved by your dealership, please contact Mercury Marine Service Office for assistance. Mercury Marine will work with you and your dealership to resolve all problems.

The following information will be needed by the service office:

- Your name and address
- Daytime telephone number
- Model and serial number of your outboard
- The name and address of your dealership
- Nature of problem

Mercury Marine Service Offices

For assistance, call, fax, or write. Please include your daytime telephone number with mail and fax correspondence.

United States		
Telephone	(920) 929-5040	Mercury Marine W6250 W. Pioneer Road P.O. Box 1939 Fond du Lac, WI 54936-1939
Fax	(920) 929-5893	
Website	www.mercurymarine.com	

Canada		
Telephone	(905) 567-6372	Mercury Marine Ltd. 2395 Meadowpine Blvd. Mississauga, Ontario L5N 7W6 Canada
Fax	(905) 567-8515	

OWNER SERVICE ASSISTANCE

Australia, Pacific		
Telephone	(61) (3) 9791-5822	Mercury Marine Australia 132-140 Frankston Road Dandenong, Victoria 3164 Australia
Fax	(61) (3) 9793-5880	

Europe, Middle East, Africa		
Telephone	(32) (87) 32 • 32 • 11	Marine Power - Europe, Inc. Parc Industriel de Petit-Rechain B-4800 Verviers, Belgium
Fax	(32) (87) 31 • 19 • 65	

Mexico, Central America, South America, Caribbean		
Telephone	(954) 744-3513	Mercury Marine 11650 Interchange Circle North Miramar, FL 33025 U.S.A.
Fax	(954) 744-3535	

Japan		
Telephone	81-053-423-2500	Mercury Marine - Japan Anshin-cho 283-1 Hamamatsu Shizuoka-ken, Japan 435-0005 Japan
Fax	81-053-423-2510	

Asia, Singapore		
Telephone	5466160	Mercury Marine Singapore 72 Loyang Way Singapore, 508762
Fax	5467789	